

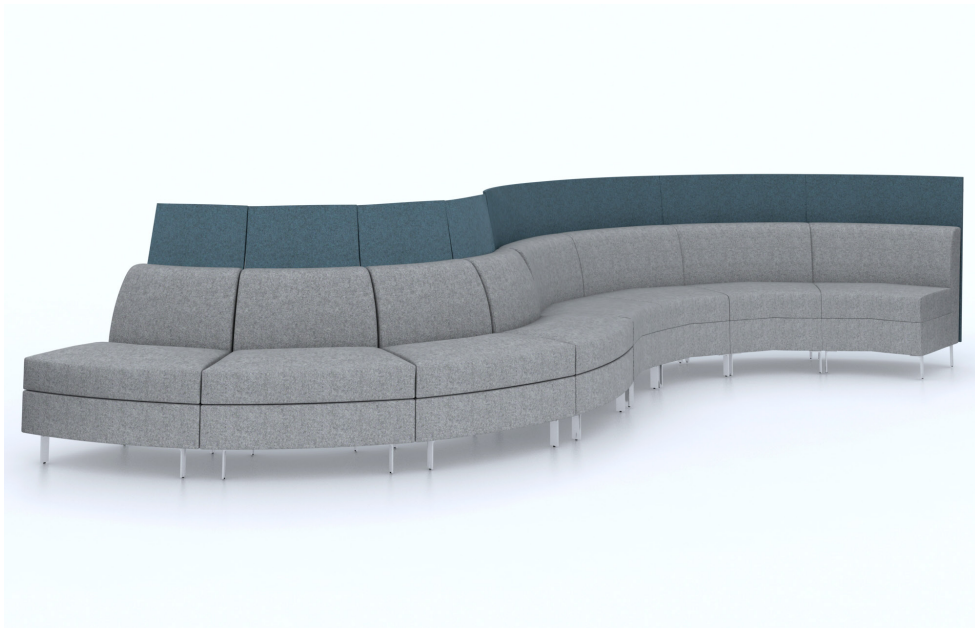

Gemini Pricebook

2018



GEMINI COLLECTION

Seat Construction: Engineered Hardwood

Floating Shelf: Surface- HPL; Core - Medium Density Particle Board

Legs: 140 mm Height Adjustable; Material - Zamak

SIN # 711-16



GE-210 Lounge	Dimensions/ Yardage	Zone Grade	COM A	B	COL C	D	E	F	G	H	I	J	K	L
	Outside: 24W 29D 34.5H	ZONE 1	\$1,136	\$1,270	\$1,337	\$1,404	\$1,471	\$1,538	\$1,605	\$1,672	\$1,739	\$1,806	\$1,873	\$1,940
	Inside: 24W 20D 15.5H	ZONE 2	\$1,193	\$1,327	\$1,394	\$1,461	\$1,528	\$1,595	\$1,662	\$1,729	\$1,795	\$1,862	\$1,929	\$1,996
	S/H 19	ZONE 3	\$1,250	\$1,384	\$1,450	\$1,517	\$1,584	\$1,651	\$1,718	\$1,785	\$1,852	\$1,919	\$1,986	\$2,053
	Yardages: Seat: 1 Base: 1/2	ZONE 4	\$1,306	\$1,440	\$1,507	\$1,574	\$1,641	\$1,708	\$1,775	\$1,842	\$1,909	\$1,976	\$2,043	\$2,110
	Back: 2	ZONE 5	\$1,363	\$1,497	\$1,564	\$1,631	\$1,698	\$1,765	\$1,832	\$1,899	\$1,966	\$2,033	\$2,100	\$2,167

Approximate Shipping weight: 55 lbs

GE-220 Love seat	Dimensions/ Yardage	Zone Grade	COM A	B	COL C	D	E	F	G	H	I	J	K	L
	Outside: 48W 29D 34.5H	ZONE 1	\$1,586	\$1,774	\$1,867	\$1,961	\$2,055	\$2,149	\$2,242	\$2,336	\$2,430	\$2,524	\$2,617	\$2,711
	Inside: 48W 20D 15.5H	ZONE 2	\$1,665	\$1,853	\$1,947	\$2,040	\$2,134	\$2,228	\$2,322	\$2,415	\$2,509	\$2,603	\$2,697	\$2,790
	S/H 19	ZONE 3	\$1,745	\$1,932	\$2,026	\$2,120	\$2,213	\$2,307	\$2,401	\$2,495	\$2,588	\$2,682	\$2,776	\$2,870
	Yardages: Seat: 1.5 Base: 3/4	ZONE 4	\$1,824	\$2,011	\$2,105	\$2,199	\$2,293	\$2,386	\$2,480	\$2,574	\$2,668	\$2,761	\$2,855	\$2,949
	Back: 3	ZONE 5	\$1,903	\$2,091	\$2,184	\$2,278	\$2,372	\$2,466	\$2,559	\$2,653	\$2,747	\$2,841	\$2,934	\$3,028

Approximate Shipping weight: 100 lbs

GE-230 Sofa	Dimensions/ Yardage	Zone Grade	COM A	B	COL C	D	E	F	G	H	I	J	K	L
	Outside: 72W 29D 34.5H	ZONE 1	\$1,857	\$2,098	\$2,219	\$2,339	\$2,460	\$2,580	\$2,701	\$2,821	\$2,942	\$3,062	\$3,183	\$3,303
	Inside: 72W 20D 15.5H	ZONE 2	\$1,950	\$2,191	\$2,311	\$2,432	\$2,553	\$2,673	\$2,794	\$2,914	\$3,035	\$3,155	\$3,276	\$3,396
	S/H 19	ZONE 3	\$2,043	\$2,284	\$2,404	\$2,525	\$2,645	\$2,766	\$2,886	\$3,007	\$3,128	\$3,248	\$3,369	\$3,489
	Yardages: Seat: 2.25 Base: 3/4	ZONE 4	\$2,136	\$2,377	\$2,497	\$2,618	\$2,738	\$2,859	\$2,979	\$3,100	\$3,220	\$3,341	\$3,461	\$3,582
	Back: 3.75	ZONE 5	\$2,228	\$2,469	\$2,590	\$2,711	\$2,831	\$2,952	\$3,072	\$3,193	\$3,313	\$3,434	\$3,554	\$3,675

Approximate Shipping weight: 140 lbs

GE-210L Lounge Left Arm Sitting	Dimensions/ Yardage	Zone Grade	COM A	B	COL C	D	E	F	G	H	I	J	K	L
	Outside: 26.5W 29D 34.5H	ZONE 1	\$1,254	\$1,442	\$1,535	\$1,629	\$1,723	\$1,817	\$1,910	\$2,004	\$2,098	\$2,192	\$2,285	\$2,379
	Inside: 24W 20D 15.5H	ZONE 2	\$1,317	\$1,504	\$1,598	\$1,692	\$1,785	\$1,879	\$1,973	\$2,067	\$2,160	\$2,254	\$2,348	\$2,442
	S/H 19 A/H	ZONE 3	\$1,379	\$1,567	\$1,661	\$1,754	\$1,848	\$1,942	\$2,036	\$2,129	\$2,223	\$2,317	\$2,411	\$2,504
	Yardages: Seat: 1 Base: 1/2	ZONE 4	\$1,442	\$1,630	\$1,723	\$1,817	\$1,911	\$2,005	\$2,098	\$2,192	\$2,286	\$2,380	\$2,473	\$2,567
	Back: 2 Arm: 1.5	ZONE 5	\$1,505	\$1,692	\$1,786	\$1,880	\$1,974	\$2,067	\$2,161	\$2,255	\$2,349	\$2,442	\$2,536	\$2,630

Approximate Shipping weight: 60 lbs

GEMINI COLLECTION

Seat Construction: Engineered Hardwood

Floating Shelf: Surface- HPL; Core - Medium Density Particle Board

Legs: 140 mm Height Adjustable; Material - Zamak

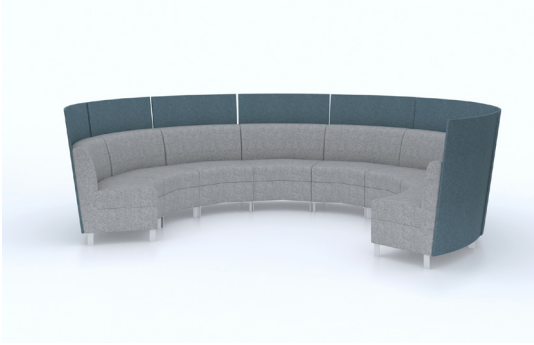

SIN # 711-16

GE-210R Lounge Right Arm Sitting		Dimensions/ Yardage	Zone Grade	COM A	B	COL C	D	E	F	G	H	I	J	K	L
	Outside: 26.5W 29D 34.5H Inside: 24W 20D 15.5H S/H 19 A/H Yardages: Seat: 1 Base: 1/2 Back: 2 Arm: 1.5	ZONE 1	\$1,254	\$1,442	\$1,535	\$1,629	\$1,723	\$1,817	\$1,910	\$2,004	\$2,098	\$2,192	\$2,285	\$2,379	
		ZONE 2	\$1,317	\$1,504	\$1,598	\$1,692	\$1,785	\$1,879	\$1,973	\$2,067	\$2,160	\$2,254	\$2,348	\$2,442	
		ZONE 3	\$1,379	\$1,567	\$1,661	\$1,754	\$1,848	\$1,942	\$2,036	\$2,129	\$2,223	\$2,317	\$2,411	\$2,504	
		ZONE 4	\$1,442	\$1,630	\$1,723	\$1,817	\$1,911	\$2,005	\$2,098	\$2,192	\$2,286	\$2,380	\$2,473	\$2,567	
		ZONE 5	\$1,505	\$1,692	\$1,786	\$1,880	\$1,974	\$2,067	\$2,161	\$2,255	\$2,349	\$2,442	\$2,536	\$2,630	

Approximate Shipping weight: 60 lbs

GE-220L Love Seat Left Arm Sitting		Dimensions/ Yardage	Zone Grade	COM A	B	COL C	D	E	F	G	H	I	J	K	L
	Outside: 50.5W 29D 34.5H Inside: 48W 20D 15.5H S/H 19 Yardages: Seat: 1.5 Base: 3/4 Back: 3 Arm: 1.5	ZONE 1	\$1,704	\$1,945	\$2,066	\$2,186	\$2,307	\$2,427	\$2,548	\$2,668	\$2,789	\$2,909	\$3,030	\$3,150	
		ZONE 2	\$1,789	\$2,030	\$2,151	\$2,271	\$2,392	\$2,512	\$2,633	\$2,753	\$2,874	\$2,995	\$3,115	\$3,236	
		ZONE 3	\$1,874	\$2,115	\$2,236	\$2,357	\$2,477	\$2,598	\$2,718	\$2,839	\$2,959	\$3,080	\$3,200	\$3,321	
		ZONE 4	\$1,960	\$2,201	\$2,321	\$2,442	\$2,562	\$2,683	\$2,803	\$2,924	\$3,044	\$3,165	\$3,285	\$3,406	
		ZONE 5	\$2,045	\$2,286	\$2,406	\$2,527	\$2,647	\$2,768	\$2,889	\$3,009	\$3,130	\$3,250	\$3,371	\$3,491	

Approximate Shipping weight: 105 lbs.

GE-220R Love Seat Right Arm Sitting		Dimensions/ Yardage	Zone Grade	COM A	B	COL C	D	E	F	G	H	I	J	K	L
	Outside: 50.5W 29D 34.5H Inside: 48W 20D 15.5H S/H 19 Yardages: Seat: 1.5 Base: 3/4 Back: 3 Arm: 1.5	ZONE 1	\$1,704	\$1,945	\$2,066	\$2,186	\$2,307	\$2,427	\$2,548	\$2,668	\$2,789	\$2,909	\$3,030	\$3,150	
		ZONE 2	\$1,789	\$2,030	\$2,151	\$2,271	\$2,392	\$2,512	\$2,633	\$2,753	\$2,874	\$2,995	\$3,115	\$3,236	
		ZONE 3	\$1,874	\$2,115	\$2,236	\$2,357	\$2,477	\$2,598	\$2,718	\$2,839	\$2,959	\$3,080	\$3,200	\$3,321	
		ZONE 4	\$1,960	\$2,201	\$2,321	\$2,442	\$2,562	\$2,683	\$2,803	\$2,924	\$3,044	\$3,165	\$3,285	\$3,406	
		ZONE 5	\$2,045	\$2,286	\$2,406	\$2,527	\$2,647	\$2,768	\$2,889	\$3,009	\$3,130	\$3,250	\$3,371	\$3,491	

Approximate Shipping weight: 105 lbs.

GE-230L Sofa Left Arm Sitting		Dimensions/ Yardage	Zone Grade	COM A	B	COL C	D	E	F	G	H	I	J	K	L
	Outside: 74.5W 29D 34.5H Inside: 72W 20D 15.5H S/H 19 Yardages: Seat: 2.25 Base: 3/4 Back: 3.75 Arm: 1.5	ZONE 1	\$1,974	\$2,269	\$2,416	\$2,563	\$2,711	\$2,858	\$3,005	\$3,153	\$3,300	\$3,447	\$3,595	\$3,742	
		ZONE 2	\$2,073	\$2,367	\$2,515	\$2,662	\$2,809	\$2,957	\$3,104	\$3,251	\$3,399	\$3,546	\$3,693	\$3,841	
		ZONE 3	\$2,171	\$2,466	\$2,613	\$2,761	\$2,908	\$3,055	\$3,203	\$3,350	\$3,497	\$3,645	\$3,792	\$3,939	
		ZONE 4	\$2,270	\$2,565	\$2,712	\$2,859	\$3,007	\$3,154	\$3,301	\$3,449	\$3,596	\$3,743	\$3,891	\$4,038	
		ZONE 5	\$2,369	\$2,663	\$2,811	\$2,958	\$3,105	\$3,253	\$3,400	\$3,547	\$3,695	\$3,842	\$3,989	\$4,137	

Approximate Shipping weight: 145 lbs

GEMINI COLLECTION

Seat Construction: Engineered Hardwood

Floating Shelf: Surface- HPL; Core - Medium Density Particle Board

Legs: 140 mm Height Adjustable; Material - Zamak



SIN # 711-16

GE-230R Sofa Right Arm Sitting		Dimensions/ Yardage	Zone Grade	COM A	B	COL C	D	E	F	G	H	I	J	K	L
	Outside: 74.5W 29D 34.5H	ZONE 1	\$1,974	\$2,269	\$2,416	\$2,563	\$2,711	\$2,858	\$3,005	\$3,153	\$3,300	\$3,447	\$3,595	\$3,742	
	Inside: 72W 20D 15.5H S/H 19	ZONE 2	\$2,073	\$2,367	\$2,515	\$2,662	\$2,809	\$2,957	\$3,104	\$3,251	\$3,399	\$3,546	\$3,693	\$3,841	
	Yardages: Seat: 2.25 Base: 3/4 Back: 3.75 Arm: 1.5	ZONE 3	\$2,171	\$2,466	\$2,613	\$2,761	\$2,908	\$3,055	\$3,203	\$3,350	\$3,497	\$3,645	\$3,792	\$3,939	
		ZONE 4	\$2,270	\$2,565	\$2,712	\$2,859	\$3,007	\$3,154	\$3,301	\$3,449	\$3,596	\$3,743	\$3,891	\$4,038	
		ZONE 5	\$2,369	\$2,663	\$2,811	\$2,958	\$3,105	\$3,253	\$3,400	\$3,547	\$3,695	\$3,842	\$3,989	\$4,137	

Approximate Shipping weight: 145 lbs

GE-210LR Lounge Two Arms		Dimensions/ Yardage	Zone Grade	COM A	B	COL C	D	E	F	G	H	I	J	K	L
	Outside: 29W 29D 34.5H	ZONE 1	\$1,371	\$1,612	\$1,733	\$1,853	\$1,974	\$2,094	\$2,215	\$2,335	\$2,456	\$2,576	\$2,697	\$2,817	
	Inside: 24W 20D 15.5H S/H 19	ZONE 2	\$1,440	\$1,681	\$1,801	\$1,922	\$2,042	\$2,163	\$2,283	\$2,404	\$2,524	\$2,645	\$2,765	\$2,886	
	Yardages: Seat: 1 Base: 1/2 Back: 2 Arms: 3	ZONE 3	\$1,508	\$1,749	\$1,870	\$1,990	\$2,111	\$2,231	\$2,352	\$2,472	\$2,593	\$2,713	\$2,834	\$2,955	
		ZONE 4	\$1,577	\$1,818	\$1,938	\$2,059	\$2,179	\$2,300	\$2,420	\$2,541	\$2,661	\$2,782	\$2,903	\$3,023	
		ZONE 5	\$1,645	\$1,886	\$2,007	\$2,127	\$2,248	\$2,368	\$2,489	\$2,609	\$2,730	\$2,851	\$2,971	\$3,092	

Approximate Shipping weight: 65 lbs

GE-220LR Love Seat Two Arms		Dimensions/ Yardage	Zone Grade	COM A	B	COL C	D	E	F	G	H	I	J	K	L
	Outside: 53W 29D 34.5H	ZONE 1	\$1,821	\$2,116	\$2,263	\$2,410	\$2,558	\$2,705	\$2,852	\$3,000	\$3,147	\$3,294	\$3,442	\$3,589	
	Inside: 48W 20D 15.5H S/H 19	ZONE 2	\$1,912	\$2,207	\$2,354	\$2,501	\$2,649	\$2,796	\$2,943	\$3,091	\$3,238	\$3,385	\$3,533	\$3,680	
	Yardages: Seat: 1.5 Base: 3/4 Back: 3 Arms: 3	ZONE 3	\$2,003	\$2,298	\$2,445	\$2,592	\$2,740	\$2,887	\$3,034	\$3,182	\$3,329	\$3,476	\$3,624	\$3,771	
		ZONE 4	\$2,094	\$2,389	\$2,536	\$2,683	\$2,831	\$2,978	\$3,125	\$3,273	\$3,420	\$3,567	\$3,715	\$3,862	
		ZONE 5	\$2,185	\$2,480	\$2,627	\$2,774	\$2,922	\$3,069	\$3,216	\$3,364	\$3,511	\$3,658	\$3,806	\$3,953	

Approximate Shipping weight: 110 lbs

GE-230LR Sofa Two Arms		Dimensions/ Yardage	Zone Grade	COM A	B	COL C	D	E	F	G	H	I	J	K	L
	Outside: 77W 29D 34.5H	ZONE 1	\$2,092	\$2,440	\$2,614	\$2,788	\$2,963	\$3,137	\$3,311	\$3,485	\$3,659	\$3,833	\$4,007	\$4,181	
	Inside: 72W 20D 15.5H S/H 19	ZONE 2	\$2,197	\$2,545	\$2,719	\$2,893	\$3,067	\$3,241	\$3,415	\$3,589	\$3,764	\$3,938	\$4,112	\$4,286	
	Yardages: Seat: 2.25 Base: 3/4 Back: 3.75 Arm: 3	ZONE 3	\$2,301	\$2,649	\$2,824	\$2,998	\$3,172	\$3,346	\$3,520	\$3,694	\$3,868	\$4,042	\$4,216	\$4,390	
		ZONE 4	\$2,406	\$2,754	\$2,928	\$3,102	\$3,276	\$3,450	\$3,625	\$3,799	\$3,973	\$4,147	\$4,321	\$4,495	
		ZONE 5	\$2,510	\$2,859	\$3,033	\$3,207	\$3,381	\$3,555	\$3,729	\$3,903	\$4,077	\$4,251	\$4,426	\$4,600	

Approximate Shipping weight: 150 lbs

GEMINI COLLECTION

Seat Construction: Engineered Hardwood

Floating Shelf: Surface- HPL; Core - Medium Density Particle Board

Legs: 140 mm Height Adjustable; Material - Zamak



SIN # 711-16

GE-211		Zone Grade	COM A	B	COL C	D	E	F	G	H	I	J	K	L
30° Concave	Dimensions/ Yardage													
	Outside: 24-40W 29D 34.5H	ZONE 1	\$1,642	\$1,847	\$1,950	\$2,053	\$2,155	\$2,258	\$2,361	\$2,463	\$2,566	\$2,669	\$2,771	\$2,874
	Inside: 24-38W 20D 15.5H S/H 19	ZONE 2	\$1,724	\$1,929	\$2,032	\$2,135	\$2,237	\$2,340	\$2,443	\$2,546	\$2,648	\$2,751	\$2,854	\$2,956
	Yardages:	ZONE 3	\$1,806	\$2,012	\$2,114	\$2,217	\$2,320	\$2,422	\$2,525	\$2,628	\$2,730	\$2,833	\$2,936	\$3,038
	Seat: 1.5 Base: 1.5 Back: 2.5	ZONE 4	\$1,888	\$2,094	\$2,196	\$2,299	\$2,402	\$2,504	\$2,607	\$2,710	\$2,812	\$2,915	\$3,018	\$3,120
		ZONE 5	\$1,970	\$2,176	\$2,278	\$2,381	\$2,484	\$2,586	\$2,689	\$2,792	\$2,895	\$2,997	\$3,100	\$3,203

Approximate Shipping weight: 50 lbs

GE-212		Zone Grade	COM A	B	COL C	D	E	F	G	H	I	J	K	L
30° Convex	Dimensions/ Yardage													
	Outside: 40-24W 29D 34.5H	ZONE 1	\$1,677	\$1,865	\$1,958	\$2,052	\$2,146	\$2,240	\$2,333	\$2,427	\$2,521	\$2,615	\$2,708	\$2,802
	Inside: 38-24W 20D 15.5H S/H 19	ZONE 2	\$1,761	\$1,948	\$2,042	\$2,136	\$2,230	\$2,323	\$2,417	\$2,511	\$2,605	\$2,698	\$2,792	\$2,886
	Yardages:	ZONE 3	\$1,845	\$2,032	\$2,126	\$2,220	\$2,313	\$2,407	\$2,501	\$2,595	\$2,688	\$2,782	\$2,876	\$2,970
	Seat: 1.5 Base: 1.5 Back: 2.5	ZONE 4	\$1,929	\$2,116	\$2,210	\$2,304	\$2,397	\$2,491	\$2,585	\$2,679	\$2,772	\$2,866	\$2,960	\$3,054
		ZONE 5	\$2,012	\$2,200	\$2,294	\$2,387	\$2,481	\$2,575	\$2,669	\$2,762	\$2,856	\$2,950	\$3,044	\$3,137

Approximate Shipping weight: 50 lbs

GE-213		Zone Grade	COM A	B	COL C	D	E	F	G	H	I	J	K	L
Corner Chair	Dimensions/ Yardage													
	Outside: 37.5W 37.5D 34.5H	ZONE 1	\$1,198	\$1,377	\$1,466	\$1,555	\$1,644	\$1,734	\$1,823	\$1,912	\$2,002	\$2,091	\$2,180	\$2,269
	Inside: 30W 30D 15.5H S/H 19	ZONE 2	\$1,258	\$1,436	\$1,526	\$1,615	\$1,704	\$1,794	\$1,883	\$1,972	\$2,061	\$2,151	\$2,240	\$2,329
	Yardages:	ZONE 3	\$1,318	\$1,496	\$1,586	\$1,675	\$1,764	\$1,854	\$1,943	\$2,032	\$2,121	\$2,211	\$2,300	\$2,389
	Seat: 1.75 Base 3/4 Back: 3.75	ZONE 4	\$1,378	\$1,556	\$1,646	\$1,735	\$1,824	\$1,913	\$2,003	\$2,092	\$2,181	\$2,271	\$2,360	\$2,449
		ZONE 5	\$1,438	\$1,616	\$1,705	\$1,795	\$1,884	\$1,973	\$2,063	\$2,152	\$2,241	\$2,330	\$2,420	\$2,509

Approximate Shipping weight: 65 lbs

GE-210-P		Zone Grade	COM A	B	COL C	D	E	F	G	H	I	J	K	L
Lounge w/ Privacy Panel	Dimensions/ Yardage													
	Outside: 24W 30D 53.5H	ZONE 1	\$1,704	\$1,892	\$1,985	\$2,079	\$2,173	\$2,267	\$2,360	\$2,454	\$2,548	\$2,642	\$2,735	\$2,829
	Inside: 24W 20D 34.5H S/H 19	ZONE 2	\$1,789	\$1,977	\$2,070	\$2,164	\$2,258	\$2,352	\$2,445	\$2,539	\$2,633	\$2,727	\$2,820	\$2,914
	Yardages:	ZONE 3	\$1,874	\$2,062	\$2,156	\$2,249	\$2,343	\$2,437	\$2,531	\$2,624	\$2,718	\$2,812	\$2,906	\$2,999
	Seat: 1 Base: 1/2 Back: 2 Panel: 1.5	ZONE 4	\$1,960	\$2,147	\$2,241	\$2,335	\$2,428	\$2,522	\$2,616	\$2,710	\$2,803	\$2,897	\$2,991	\$3,085
		ZONE 5	\$2,045	\$2,232	\$2,326	\$2,420	\$2,514	\$2,607	\$2,701	\$2,795	\$2,889	\$2,982	\$3,076	\$3,170

Approximate Shipping weight: 55 lbs

GEMINI COLLECTION

Seat Construction: Engineered Hardwood

Floating Shelf: Surface- HPL; Core - Medium Density Particle Board

Legs: 140 mm Height Adjustable; Material - Zamak



SIN # 711-16

GE-220-P		Zone Grade	Dimensions/ Yardage											
Love Seat w/ Privacy Panel	COM A		B	COL C	D	E	F	G	H	I	J	K	L	
	Outside: 48W 30D 53.5H	ZONE 1	\$2,379	\$2,656	\$2,794	\$2,933	\$3,071	\$3,209	\$3,348	\$3,486	\$3,625	\$3,763	\$3,901	\$4,040
	Inside: 48W 20D 34.5H S/H 19	ZONE 2	\$2,498	\$2,775	\$2,913	\$3,052	\$3,190	\$3,328	\$3,467	\$3,605	\$3,743	\$3,882	\$4,020	\$4,159
	Yardages: Seat: 1.5 Base: 3/4 Back: 3 Panel: 2.5	ZONE 3	\$2,617	\$2,894	\$3,032	\$3,170	\$3,309	\$3,447	\$3,586	\$3,724	\$3,862	\$4,001	\$4,139	\$4,278
		ZONE 4	\$2,736	\$3,013	\$3,151	\$3,289	\$3,428	\$3,566	\$3,705	\$3,843	\$3,981	\$4,120	\$4,258	\$4,397
		ZONE 5	\$2,855	\$3,132	\$3,270	\$3,408	\$3,547	\$3,685	\$3,824	\$3,962	\$4,100	\$4,239	\$4,377	\$4,516

Approximate Shipping weight: 100 lbs

GE-230-P		Zone Grade	Dimensions/ Yardage											
Sofa w/ Privacy Panel	COM A		B	COL C	D	E	F	G	H	I	J	K	L	
	Outside: 72W 30D 53.5H	ZONE 1	\$2,785	\$3,187	\$3,388	\$3,589	\$3,789	\$3,990	\$4,191	\$4,392	\$4,593	\$4,794	\$4,995	\$5,196
	Inside: 72W 20D 34.5H S/H 19	ZONE 2	\$2,924	\$3,326	\$3,527	\$3,728	\$3,929	\$4,130	\$4,331	\$4,531	\$4,732	\$4,933	\$5,134	\$5,335
	Yardages: Seat: 2.25 Base: 3/4 Back: 3.75 Panel: 4.5	ZONE 3	\$3,064	\$3,465	\$3,666	\$3,867	\$4,068	\$4,269	\$4,470	\$4,671	\$4,872	\$5,072	\$5,273	\$5,474
		ZONE 4	\$3,203	\$3,605	\$3,805	\$4,006	\$4,207	\$4,408	\$4,609	\$4,810	\$5,011	\$5,212	\$5,413	\$5,613
		ZONE 5	\$3,342	\$3,744	\$3,945	\$4,146	\$4,346	\$4,547	\$4,748	\$4,949	\$5,150	\$5,351	\$5,552	\$5,753

Approximate Shipping weight: 140 lbs

GE-210R-P		Zone Grade	Dimensions/ Yardage											
Lounge Left Arm Sitting w/ Privacy Panel	COM A		B	COL C	D	E	F	G	H	I	J	K	L	
	Outside: 26.5W 30D 53.5H	ZONE 1	\$1,880	\$2,121	\$2,242	\$2,362	\$2,483	\$2,603	\$2,724	\$2,844	\$2,965	\$3,085	\$3,206	\$3,326
	Inside: 24W 20D 34.5H S/H 19	ZONE 2	\$1,974	\$2,215	\$2,336	\$2,456	\$2,577	\$2,697	\$2,818	\$2,938	\$3,059	\$3,179	\$3,300	\$3,420
	Yds: Seat: 1 Base: 1/2 Back: 2 Arm: 1.5 Panel: 1.5	ZONE 3	\$2,068	\$2,309	\$2,430	\$2,550	\$2,671	\$2,791	\$2,912	\$3,032	\$3,153	\$3,273	\$3,394	\$3,514
		ZONE 4	\$2,162	\$2,403	\$2,524	\$2,644	\$2,765	\$2,885	\$3,006	\$3,126	\$3,247	\$3,367	\$3,488	\$3,608
		ZONE 5	\$2,256	\$2,497	\$2,618	\$2,738	\$2,859	\$2,979	\$3,100	\$3,220	\$3,341	\$3,461	\$3,582	\$3,702

Approximate Shipping weight: 60 lbs

GE-210L-P		Zone Grade	Dimensions/ Yardage											
Lounge Right Arm Sitting w/ Privacy Panel	COM A		B	COL C	D	E	F	G	H	I	J	K	L	
	Outside: 26.5W 30D 53.5H	ZONE 1	\$1,880	\$2,121	\$2,242	\$2,362	\$2,483	\$2,603	\$2,724	\$2,844	\$2,965	\$3,085	\$3,206	\$3,326
	Inside: 24W 20D 34.5H S/H 19	ZONE 2	\$1,974	\$2,215	\$2,336	\$2,456	\$2,577	\$2,697	\$2,818	\$2,938	\$3,059	\$3,179	\$3,300	\$3,420
	Yds: Seat: 1 Base: 1/2 Back: 2 Arm: 1.5 Panel: 1.5	ZONE 3	\$2,068	\$2,309	\$2,430	\$2,550	\$2,671	\$2,791	\$2,912	\$3,032	\$3,153	\$3,273	\$3,394	\$3,514
		ZONE 4	\$2,162	\$2,403	\$2,524	\$2,644	\$2,765	\$2,885	\$3,006	\$3,126	\$3,247	\$3,367	\$3,488	\$3,608
		ZONE 5	\$2,256	\$2,497	\$2,618	\$2,738	\$2,859	\$2,979	\$3,100	\$3,220	\$3,341	\$3,461	\$3,582	\$3,702

Approximate Shipping weight: 60 lbs

GEMINI COLLECTION

Seat Construction: Engineered Hardwood

Floating Shelf: Surface- HPL; Core - Medium Density Particle Board

Legs: 140 mm Height Adjustable; Material - Zamak

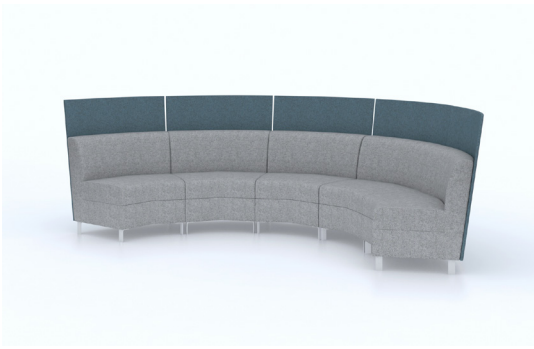

SIN # 711-16

GE-220L-P														
Love Seat Left Arm Sitting w/ Privacy Panel	Dimensions/ Yardage	Zone Grade	COM A	B	COL C	D	E	F	G	H	I	J	K	L
	Outside: 50.5W 30D 53.5H Inside: 48W 20D 34.5H S/H 19 Seat: 1.5 Base: 3/4 Back: 3 Arm: 1.5 Panel: 2.5	ZONE 1	\$2,556	\$2,886	\$3,052	\$3,217	\$3,382	\$3,547	\$3,712	\$3,877	\$4,043	\$4,208	\$4,373	\$4,538
		ZONE 2	\$2,684	\$3,014	\$3,179	\$3,345	\$3,510	\$3,675	\$3,840	\$4,005	\$4,170	\$4,336	\$4,501	\$4,666
		ZONE 3	\$2,812	\$3,142	\$3,307	\$3,472	\$3,637	\$3,803	\$3,968	\$4,133	\$4,298	\$4,463	\$4,629	\$4,794
		ZONE 4	\$2,939	\$3,270	\$3,435	\$3,600	\$3,765	\$3,930	\$4,096	\$4,261	\$4,426	\$4,591	\$4,756	\$4,922
		ZONE 5	\$3,067	\$3,398	\$3,563	\$3,728	\$3,893	\$4,058	\$4,223	\$4,389	\$4,554	\$4,719	\$4,884	\$5,049

Approximate Shipping weight: 105 lbs.

GE-220R-P														
Love Seat Right Arm Sitting w/ Privacy Panel	Dimensions/ Yardage	Zone Grade	COM A	B	COL C	D	E	F	G	H	I	J	K	L
	Outside: 50.5W 30D 53.5H Inside: 48W 20D 34.5H S/H 19 Yds: Seat: 1.5 Base: 3/4 Back: 3 Arm: 1.5 Panel: 2.5	ZONE 1	\$2,556	\$2,886	\$3,052	\$3,217	\$3,382	\$3,547	\$3,712	\$3,877	\$4,043	\$4,208	\$4,373	\$4,538
		ZONE 2	\$2,812	\$3,142	\$3,307	\$3,472	\$3,637	\$3,803	\$3,968	\$4,133	\$4,298	\$4,463	\$4,629	\$4,794
		ZONE 3	\$2,939	\$3,270	\$3,435	\$3,600	\$3,765	\$3,930	\$4,096	\$4,261	\$4,426	\$4,591	\$4,756	\$4,922
		ZONE 4	\$3,067	\$3,398	\$3,563	\$3,728	\$3,893	\$4,058	\$4,223	\$4,389	\$4,554	\$4,719	\$4,884	\$5,049
		ZONE 5	\$3,067	\$3,398	\$3,563	\$3,728	\$3,893	\$4,058	\$4,223	\$4,389	\$4,554	\$4,719	\$4,884	\$5,049

Approximate Shipping weight: 105 lbs.

GE-230L-P														
Sofa Left Arm Sitting w/ Privacy Panel	Dimensions/ Yardage	Zone Grade	COM A	B	COL C	D	E	F	G	H	I	J	K	L
	Outside: 74.5W 30D 53.5H Inside: 72W 20D 34.5H S/H 19 Yds: Seat: 2.25 Base: 3/4 Back: 3.75 Arm: 1.5 Panel: 4.5	ZONE 1	\$2,962	\$3,417	\$3,645	\$3,873	\$4,100	\$4,328	\$4,556	\$4,783	\$5,011	\$5,239	\$5,466	\$5,694
		ZONE 2	\$3,110	\$3,565	\$3,793	\$4,021	\$4,248	\$4,476	\$4,704	\$4,932	\$5,159	\$5,387	\$5,615	\$5,842
		ZONE 3	\$3,258	\$3,714	\$3,941	\$4,169	\$4,397	\$4,624	\$4,852	\$5,080	\$5,307	\$5,535	\$5,763	\$5,990
		ZONE 4	\$3,406	\$3,862	\$4,089	\$4,317	\$4,545	\$4,772	\$5,000	\$5,228	\$5,455	\$5,683	\$5,911	\$6,138
		ZONE 5	\$3,554	\$4,010	\$4,237	\$4,465	\$4,693	\$4,920	\$5,148	\$5,376	\$5,604	\$5,831	\$6,059	\$6,287

Approximate Shipping weight: 145 lbs

GE-230R-P														
Sofa Right Arm Sitting w/ Privacy Panel	Dimensions/ Yardage	Zone Grade	COM A	B	COL C	D	E	F	G	H	I	J	K	L
	Outside: 74.5W 30D 53.5H Inside: 72W 20D 34.5H S/H 19 Yds: Seat: 2.25 Base: 3/4 Back: 3.75 Arm: 1.5 Panel: 4.5	ZONE 1	\$2,962	\$3,417	\$3,645	\$3,873	\$4,100	\$4,328	\$4,556	\$4,783	\$5,011	\$5,239	\$5,466	\$5,694
		ZONE 2	\$3,110	\$3,565	\$3,793	\$4,021	\$4,248	\$4,476	\$4,704	\$4,932	\$5,159	\$5,387	\$5,615	\$5,842
		ZONE 3	\$3,258	\$3,714	\$3,941	\$4,169	\$4,397	\$4,624	\$4,852	\$5,080	\$5,307	\$5,535	\$5,763	\$5,990
		ZONE 4	\$3,406	\$3,862	\$4,089	\$4,317	\$4,545	\$4,772	\$5,000	\$5,228	\$5,455	\$5,683	\$5,911	\$6,138
		ZONE 5	\$3,554	\$4,010	\$4,237	\$4,465	\$4,693	\$4,920	\$5,148	\$5,376	\$5,604	\$5,831	\$6,059	\$6,287

Approximate Shipping weight: 145 lbs

GEMINI COLLECTION

Seat Construction: Engineered Hardwood

Floating Shelf: Surface- HPL; Core - Medium Density Particle Board

Legs: 140 mm Height Adjustable; Material - Zamak

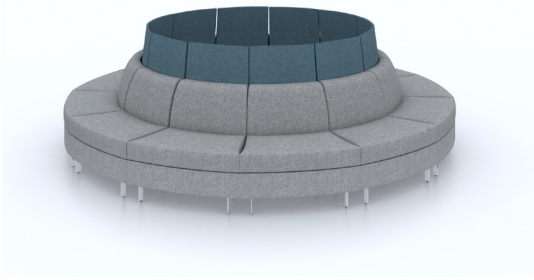

SIN # 711-16

GE-210LR-P														
Lounge Two Arms w/ Privacy Panel	Dimensions/ Yardage	Zone Grade	COM A	B	COL C	D	E	F	G	H	I	J	K	L
	Outside: 29W 30D 53.5H Inside: 24W 20D 34.5H S/H 19 Yds: Seat: 1 Base: 1/2 Back: 2 Arms: 3 Panel: 1.5	ZONE 1	\$2,057	\$2,352	\$2,499	\$2,646	\$2,794	\$2,941	\$3,088	\$3,236	\$3,383	\$3,530	\$3,678	\$3,825
		ZONE 2	\$2,160	\$2,454	\$2,602	\$2,749	\$2,896	\$3,044	\$3,191	\$3,338	\$3,486	\$3,633	\$3,780	\$3,928
		ZONE 3	\$2,263	\$2,557	\$2,705	\$2,852	\$2,999	\$3,147	\$3,294	\$3,441	\$3,589	\$3,736	\$3,883	\$4,031
		ZONE 4	\$2,366	\$2,660	\$2,808	\$2,955	\$3,102	\$3,249	\$3,397	\$3,544	\$3,691	\$3,839	\$3,986	\$4,133
		ZONE 5	\$2,468	\$2,763	\$2,910	\$3,058	\$3,205	\$3,352	\$3,500	\$3,647	\$3,794	\$3,942	\$4,089	\$4,236

Approximate Shipping weight: 65 lbs

GE-220LR-P														
Love Seat Two Arms w/ Privacy Panel	Dimensions/ Yardage	Zone Grade	COM A	B	COL C	D	E	F	G	H	I	J	K	L
	Outside: 53W 30D 53.5H Inside: 48W 20D 34.5H S/H 19 Yds: Seat: 1.5 Base: 3/4 Back: 3 Arms: 3 Panel: 2.5	ZONE 1	\$2,732	\$3,116	\$3,308	\$3,500	\$3,692	\$3,884	\$4,076	\$4,268	\$4,460	\$4,652	\$4,844	\$5,036
		ZONE 2	\$3,005	\$3,389	\$3,581	\$3,773	\$3,965	\$4,157	\$4,349	\$4,541	\$4,733	\$4,925	\$5,117	\$5,309
		ZONE 3	\$3,142	\$3,526	\$3,718	\$3,910	\$4,102	\$4,294	\$4,486	\$4,678	\$4,869	\$5,061	\$5,253	\$5,445
		ZONE 4	\$3,278	\$3,662	\$3,854	\$4,046	\$4,238	\$4,430	\$4,622	\$4,814	\$5,006	\$5,198	\$5,390	\$5,582
		ZONE 5	\$3,278	\$3,669	\$3,865	\$4,061	\$4,256	\$4,452	\$4,648	\$4,843	\$5,039	\$5,234	\$5,430	\$5,626

Approximate Shipping weight: 110 lbs

GE-230LR-P														
Sofa Two Arms w/ Privacy Panel	Dimensions/ Yardage	Zone Grade	COM A	B	COL C	D	E	F	G	H	I	J	K	L
	Outside: 77W 30D 53.5H Inside: 72W 20D 34.5H S/H 19 Yds: Seat: 2.25 Base: 3/4 Back: 3.75 Arm: 3 Panel: 4.5	ZONE 1	\$3,138	\$3,647	\$3,901	\$4,156	\$4,410	\$4,665	\$4,919	\$5,174	\$5,428	\$5,683	\$5,937	\$6,192
		ZONE 2	\$3,295	\$3,804	\$4,058	\$4,313	\$4,567	\$4,822	\$5,076	\$5,331	\$5,585	\$5,840	\$6,094	\$6,348
		ZONE 3	\$3,452	\$3,961	\$4,215	\$4,470	\$4,724	\$4,979	\$5,233	\$5,488	\$5,742	\$5,996	\$6,251	\$6,505
		ZONE 4	\$3,609	\$4,118	\$4,372	\$4,627	\$4,881	\$5,135	\$5,390	\$5,644	\$5,899	\$6,153	\$6,408	\$6,662
		ZONE 5	\$3,766	\$4,275	\$4,529	\$4,783	\$5,038	\$5,292	\$5,547	\$5,801	\$6,056	\$6,310	\$6,565	\$6,819

Approximate Shipping weight: 150 lbs

GE-211-P														
30° Concave w/ Privacy Panel	Dimensions/ Yardage	Zone Grade	COM A	B	COL C	D	E	F	G	H	I	J	K	L
	Outside: 24-40W 30D 53.5H Inside: 24-38W 20D 34.5H S/H 19 Yardages: Seat: 1.5 Base: 1.5 Back: 2.5 Panel: 2	ZONE 1	\$2,463	\$2,740	\$2,878	\$3,017	\$3,155	\$3,293	\$3,432	\$3,570	\$3,709	\$3,847	\$3,985	\$4,124
		ZONE 2	\$2,586	\$2,863	\$3,001	\$3,140	\$3,278	\$3,417	\$3,555	\$3,693	\$3,832	\$3,970	\$4,108	\$4,247
		ZONE 3	\$2,709	\$2,986	\$3,124	\$3,263	\$3,401	\$3,540	\$3,678	\$3,816	\$3,955	\$4,093	\$4,232	\$4,370
		ZONE 4	\$2,832	\$3,109	\$3,248	\$3,386	\$3,524	\$3,663	\$3,801	\$3,940	\$4,078	\$4,216	\$4,355	\$4,493
		ZONE 5	\$2,956	\$3,232	\$3,371	\$3,509	\$3,648	\$3,786	\$3,924	\$4,063	\$4,201	\$4,340	\$4,478	\$4,616

Approximate Shipping weight: 50 lbs

GEMINI COLLECTION

Seat Construction: Engineered Hardwood

Floating Shelf: Surface- HPL; Core - Medium Density Particle Board

Legs: 140 mm Height Adjustable; Material - Zamak



SIN # 711-16

GE-212-P		Zone	COM		COL									
30° Convex w/ Privacy Panel	Dimensions/ Yardage	Grade	A	B	C	D	E	F	G	H	I	J	K	L
	Outside: 40-24W 30D 53.5H	ZONE 1	\$2,516	\$2,775	\$2,904	\$3,034	\$3,163	\$3,293	\$3,422	\$3,552	\$3,681	\$3,811	\$3,940	\$4,070
	Inside: 38-24W 20D 34.5H	ZONE 2	\$2,642	\$2,901	\$3,030	\$3,160	\$3,289	\$3,419	\$3,548	\$3,678	\$3,807	\$3,936	\$4,066	\$4,195
	S/H 19	ZONE 3	\$2,768	\$3,027	\$3,156	\$3,285	\$3,415	\$3,544	\$3,674	\$3,803	\$3,933	\$4,062	\$4,192	\$4,321
	Yardages: Seat: 1.5 Base: 1.5	ZONE 4	\$2,893	\$3,152	\$3,282	\$3,411	\$3,541	\$3,670	\$3,800	\$3,929	\$4,059	\$4,188	\$4,318	\$4,447
	Back: 2.5 Panel: 2	ZONE 5	\$3,019	\$3,278	\$3,408	\$3,537	\$3,667	\$3,796	\$3,925	\$4,055	\$4,184	\$4,314	\$4,443	\$4,573

Approximate Shipping weight: 50 lbs

GE-213-P		Zone	COM		COL									
Corner Chair w/ Privacy Panel	Dimensions/ Yardage	Grade	A	B	C	D	E	F	G	H	I	J	K	L
	Outside: 38.5W 38.5D 53.5H	ZONE 1	\$2,386	\$2,725	\$2,895	\$3,065	\$3,234	\$3,404	\$3,574	\$3,743	\$3,913	\$4,082	\$4,252	\$4,422
	Inside: 30W 30D 34.5H	ZONE 2	\$2,505	\$2,845	\$3,014	\$3,184	\$3,354	\$3,523	\$3,693	\$3,862	\$4,032	\$4,202	\$4,371	\$4,541
	S/H 19	ZONE 3	\$2,625	\$2,964	\$3,134	\$3,303	\$3,473	\$3,642	\$3,812	\$3,982	\$4,151	\$4,321	\$4,491	\$4,660
	Yardages: Seat: 1.75 Base: 3/4	ZONE 4	\$2,744	\$3,083	\$3,253	\$3,422	\$3,592	\$3,762	\$3,931	\$4,101	\$4,271	\$4,440	\$4,610	\$4,780
	Back: 3.75 Panel: 4.5	ZONE 5	\$2,863	\$3,202	\$3,372	\$3,542	\$3,711	\$3,881	\$4,051	\$4,220	\$4,390	\$4,560	\$4,729	\$4,899

Approximate Shipping weight: 65 lbs

GE-310		Zone	COM		COL									
High Back Lounge	Dimensions/ Yardage	Grade	A	B	C	D	E	F	G	H	I	J	K	L
	Outside: 24W 29D 59.5H	ZONE 1	\$1,420	\$1,581	\$1,661	\$1,741	\$1,822	\$1,902	\$1,983	\$2,063	\$2,143	\$2,224	\$2,304	\$2,384
	Inside: 24W 20D 40.5H	ZONE 2	\$1,491	\$1,652	\$1,732	\$1,812	\$1,893	\$1,973	\$2,054	\$2,134	\$2,214	\$2,295	\$2,375	\$2,455
	S/H 19	ZONE 3	\$1,562	\$1,723	\$1,803	\$1,883	\$1,964	\$2,044	\$2,125	\$2,205	\$2,285	\$2,366	\$2,446	\$2,526
	Yardages: Seat: 1 Base: 1/2	ZONE 4	\$1,633	\$1,794	\$1,874	\$1,954	\$2,035	\$2,115	\$2,196	\$2,276	\$2,356	\$2,437	\$2,517	\$2,597
	Back: 2	ZONE 5	\$1,704	\$1,865	\$1,945	\$2,025	\$2,106	\$2,186	\$2,267	\$2,347	\$2,427	\$2,508	\$2,588	\$2,668

Approximate Shipping weight: 70lbs

GE-320		Zone	COM		COL									
High Back Love seat	Dimensions/ Yardage	Grade	A	B	C	D	E	F	G	H	I	J	K	L
	Outside: 48W 29D 59.5H	ZONE 1	\$1,983	\$2,206	\$2,318	\$2,429	\$2,541	\$2,653	\$2,764	\$2,876	\$2,987	\$3,099	\$3,211	\$3,322
	Inside: 48W 20D 40.5H	ZONE 2	\$2,082	\$2,305	\$2,417	\$2,529	\$2,640	\$2,752	\$2,863	\$2,975	\$3,087	\$3,198	\$3,310	\$3,421
	S/H 19	ZONE 3	\$2,181	\$2,405	\$2,516	\$2,628	\$2,739	\$2,851	\$2,963	\$3,074	\$3,186	\$3,297	\$3,409	\$3,521
	Yardages: Seat: 1.5 Base: 3/4	ZONE 4	\$2,280	\$2,504	\$2,615	\$2,727	\$2,838	\$2,950	\$3,062	\$3,173	\$3,285	\$3,397	\$3,508	\$3,620
	Back: 3	ZONE 5	\$2,380	\$2,603	\$2,714	\$2,826	\$2,938	\$3,049	\$3,161	\$3,272	\$3,384	\$3,496	\$3,607	\$3,719

Approximate Shipping weight: 125 lbs

GEMINI COLLECTION

Seat Construction: Engineered Hardwood

Floating Shelf: Surface- HPL; Core - Medium Density Particle Board

Legs: 140 mm Height Adjustable; Material - Zamak



SIN # 711-16

GE-330		Zone	COM		COL									
High Back Sofa	Dimensions/ Yardage	Grade	A	B	C	D	E	F	G	H	I	J	K	L
	Outside: 72W 29D 59.5H	ZONE 1	\$2,321	\$2,634	\$2,790	\$2,946	\$3,102	\$3,259	\$3,415	\$3,571	\$3,727	\$3,884	\$4,040	\$4,196
	Inside: 72W 20D 40.5H	ZONE 2	\$2,437	\$2,750	\$2,906	\$3,062	\$3,218	\$3,375	\$3,531	\$3,687	\$3,843	\$4,000	\$4,156	\$4,312
	S/H 19	ZONE 3	\$2,553	\$2,866	\$3,022	\$3,178	\$3,334	\$3,491	\$3,647	\$3,803	\$3,959	\$4,116	\$4,272	\$4,428
	Yardages: Seat: 2.25 Base: 3/4	ZONE 4	\$2,669	\$2,982	\$3,138	\$3,294	\$3,450	\$3,607	\$3,763	\$3,919	\$4,075	\$4,232	\$4,388	\$4,544
	Back: 3.75	ZONE 5	\$2,785	\$3,098	\$3,254	\$3,410	\$3,566	\$3,723	\$3,879	\$4,035	\$4,191	\$4,348	\$4,504	\$4,660

Approximate Shipping weight: 175 lbs

GE-310R		Zone	COM		COL									
High Back Lounge Left Arm Sitting	Dimensions/ Yardage	Grade	A	B	C	D	E	F	G	H	I	J	K	L
	Outside: 26.5W 29D 59.5H	ZONE 1	\$1,567	\$1,826	\$1,955	\$2,085	\$2,214	\$2,344	\$2,473	\$2,603	\$2,732	\$2,862	\$2,991	\$3,121
	Inside: 24W 20D 40.5H	ZONE 2	\$1,645	\$1,904	\$2,034	\$2,163	\$2,293	\$2,422	\$2,552	\$2,681	\$2,811	\$2,940	\$3,069	\$3,199
	S/H 19 A/H	ZONE 3	\$1,724	\$1,983	\$2,112	\$2,242	\$2,371	\$2,500	\$2,630	\$2,759	\$2,889	\$3,018	\$3,148	\$3,277
	Yardages: Seat: 1 Base: 1/2	ZONE 4	\$1,802	\$2,061	\$2,190	\$2,320	\$2,449	\$2,579	\$2,708	\$2,838	\$2,967	\$3,097	\$3,226	\$3,356
	Back: 2 Arm: 1.5	ZONE 5	\$1,880	\$2,139	\$2,269	\$2,398	\$2,528	\$2,657	\$2,787	\$2,916	\$3,046	\$3,175	\$3,305	\$3,434

Approximate Shipping weight: 80 lbs

GE-310L		Zone	COM		COL									
High Back Lounge Right Arm Sitting	Dimensions/ Yardage	Grade	A	B	C	D	E	F	G	H	I	J	K	L
	Outside: 26.5W 29D 59.5H	ZONE 1	\$1,567	\$1,826	\$1,955	\$2,085	\$2,214	\$2,344	\$2,473	\$2,603	\$2,732	\$2,862	\$2,991	\$3,121
	Inside: 24W 20D 40.5H	ZONE 2	\$1,645	\$1,904	\$2,034	\$2,163	\$2,293	\$2,422	\$2,552	\$2,681	\$2,811	\$2,940	\$3,069	\$3,199
	S/H 19 A/H	ZONE 3	\$1,724	\$1,983	\$2,112	\$2,242	\$2,371	\$2,500	\$2,630	\$2,759	\$2,889	\$3,018	\$3,148	\$3,277
	Yardages: Seat: 1 Base: 1/2	ZONE 4	\$1,802	\$2,061	\$2,190	\$2,320	\$2,449	\$2,579	\$2,708	\$2,838	\$2,967	\$3,097	\$3,226	\$3,356
	Back: 2 Arm: 1.5	ZONE 5	\$1,880	\$2,139	\$2,269	\$2,398	\$2,528	\$2,657	\$2,787	\$2,916	\$3,046	\$3,175	\$3,305	\$3,434

Approximate Shipping weight: 80 lbs

GE-320L		Zone	COM		COL									
High Back Love Seat Left Arm Sitting	Dimensions/ Yardage	Grade	A	B	C	D	E	F	G	H	I	J	K	L
	Outside: 50.5W 29D 59.5H	ZONE 1	\$2,130	\$2,451	\$2,612	\$2,773	\$2,934	\$3,094	\$3,255	\$3,416	\$3,576	\$3,737	\$3,898	\$4,059
	Inside: 48W 20D 40.5H	ZONE 2	\$2,237	\$2,558	\$2,719	\$2,879	\$3,040	\$3,201	\$3,362	\$3,522	\$3,683	\$3,844	\$4,004	\$4,165
	S/H 19	ZONE 3	\$2,343	\$2,664	\$2,825	\$2,986	\$3,147	\$3,307	\$3,468	\$3,629	\$3,789	\$3,950	\$4,111	\$4,272
	Yardages: Seat: 1.5 Base: 3/4	ZONE 4	\$2,450	\$2,771	\$2,932	\$3,092	\$3,253	\$3,414	\$3,575	\$3,735	\$3,896	\$4,057	\$4,217	\$4,378
	Back: 3 Arm: 1.5	ZONE 5	\$2,556	\$2,877	\$3,038	\$3,199	\$3,360	\$3,520	\$3,681	\$3,842	\$4,002	\$4,163	\$4,324	\$4,485

High Back

Approximate Shipping weight: 135 lbs

GEMINI COLLECTION

Seat Construction: Engineered Hardwood

Floating Shelf: Surface- HPL; Core - Medium Density Particle Board

Legs: 140 mm Height Adjustable; Material - Zamak



SIN # 711-16

GE-320R		Zone	COM		COL									
High Back Love Seat Right Arm Sitting	Dimensions/ Yardage	Grade	A	B	C	D	E	F	G	H	I	J	K	L
	Outside: 50.5W 29D 59.5H	ZONE 1	\$2,130	\$2,451	\$2,612	\$2,773	\$2,934	\$3,094	\$3,255	\$3,416	\$3,576	\$3,737	\$3,898	\$4,059
	Inside: 48W 20D 40.5H S/H 19	ZONE 2	\$2,343	\$2,664	\$2,825	\$2,986	\$3,147	\$3,307	\$3,468	\$3,629	\$3,789	\$3,950	\$4,111	\$4,272
	Yardages: Seat: 1.5 Base: 3/4 Back: 3 Arm: 1.5	ZONE 3	\$2,450	\$2,771	\$2,932	\$3,092	\$3,253	\$3,414	\$3,575	\$3,735	\$3,896	\$4,057	\$4,217	\$4,378
		ZONE 4	\$2,556	\$2,877	\$3,038	\$3,199	\$3,360	\$3,520	\$3,681	\$3,842	\$4,002	\$4,163	\$4,324	\$4,485
		ZONE 5	\$2,556	\$2,877	\$3,038	\$3,199	\$3,360	\$3,520	\$3,681	\$3,842	\$4,002	\$4,163	\$4,324	\$4,485

Approximate Shipping weight: 135 lbs

GE-330L		Zone	COM		COL									
High Back Sofa Left Arm Sitting	Dimensions/ Yardage	Grade	A	B	C	D	E	F	G	H	I	J	K	L
	Outside: 74.5W 29D 59.5H	ZONE 1	\$2,468	\$2,879	\$3,084	\$3,289	\$3,495	\$3,700	\$3,906	\$4,111	\$4,316	\$4,522	\$4,727	\$4,932
	Inside: 72W 20D 40.5H S/H 19	ZONE 2	\$2,591	\$3,002	\$3,207	\$3,413	\$3,618	\$3,824	\$4,029	\$4,234	\$4,440	\$4,645	\$4,850	\$5,056
	Yardages: Seat: 2.25 Base: 3/4 Back: 3.75 Arm: 1.5	ZONE 3	\$2,715	\$3,126	\$3,331	\$3,536	\$3,742	\$3,947	\$4,152	\$4,358	\$4,563	\$4,768	\$4,974	\$5,179
		ZONE 4	\$2,838	\$3,249	\$3,454	\$3,660	\$3,865	\$4,070	\$4,276	\$4,481	\$4,686	\$4,892	\$5,097	\$5,302
		ZONE 5	\$2,962	\$3,372	\$3,578	\$3,783	\$3,988	\$4,194	\$4,399	\$4,604	\$4,810	\$5,015	\$5,221	\$5,426

Approximate Shipping weight: 185 lbs

GE-330R		Zone	COM		COL									
High Back Sofa Right Arm Sitting	Dimensions/ Yardage	Grade	A	B	C	D	E	F	G	H	I	J	K	L
	Outside: 74.5W 29D 59.5H	ZONE 1	\$2,468	\$2,879	\$3,084	\$3,289	\$3,495	\$3,700	\$3,906	\$4,111	\$4,316	\$4,522	\$4,727	\$4,932
	Inside: 72W 20D 40.5H S/H 19	ZONE 2	\$2,591	\$3,002	\$3,207	\$3,413	\$3,618	\$3,824	\$4,029	\$4,234	\$4,440	\$4,645	\$4,850	\$5,056
	Yardages: Seat: 2.25 Base: 3/4 Back: 3.75 Arm: 1.5	ZONE 3	\$2,715	\$3,126	\$3,331	\$3,536	\$3,742	\$3,947	\$4,152	\$4,358	\$4,563	\$4,768	\$4,974	\$5,179
		ZONE 4	\$2,838	\$3,249	\$3,454	\$3,660	\$3,865	\$4,070	\$4,276	\$4,481	\$4,686	\$4,892	\$5,097	\$5,302
		ZONE 5	\$2,962	\$3,372	\$3,578	\$3,783	\$3,988	\$4,194	\$4,399	\$4,604	\$4,810	\$5,015	\$5,221	\$5,426

Approximate Shipping weight: 185 lbs

GE-310LR		Zone	COM		COL									
High Back Lounge Two Arms	Dimensions/ Yardage	Grade	A	B	C	D	E	F	G	H	I	J	K	L
	Outside: 29W 29D 59.5H	ZONE 1	\$1,714	\$2,071	\$2,250	\$2,428	\$2,607	\$2,785	\$2,964	\$3,143	\$3,321	\$3,500	\$3,678	\$3,857
	Inside: 24W 20D 40.5H S/H 19	ZONE 2	\$1,800	\$2,157	\$2,335	\$2,514	\$2,693	\$2,871	\$3,050	\$3,228	\$3,407	\$3,585	\$3,764	\$3,943
	Yardages: Seat: 1 Base: 1/2 Back: 2 Arms: 3	ZONE 3	\$1,885	\$2,243	\$2,421	\$2,600	\$2,778	\$2,957	\$3,135	\$3,314	\$3,493	\$3,671	\$3,850	\$4,028
		ZONE 4	\$1,971	\$2,328	\$2,507	\$2,685	\$2,864	\$3,043	\$3,221	\$3,400	\$3,578	\$3,757	\$3,935	\$4,114
		ZONE 5	\$2,057	\$2,414	\$2,593	\$2,771	\$2,950	\$3,128	\$3,307	\$3,485	\$3,664	\$3,843	\$4,021	\$4,200

Approximate Shipping weight: 75 lbs

GEMINI COLLECTION

Seat Construction: Engineered Hardwood

Floating Shelf: Surface- HPL; Core - Medium Density Particle Board

Legs: 140 mm Height Adjustable; Material - Zamak



SIN # 711-16

GE-320LR		Zone	COM		COL									
High Back Love Seat Two Arms	Dimensions/ Yardage	Grade	A	B	C	D	E	F	G	H	I	J	K	L
	Outside: 53W 29D 59.5H	ZONE 1	\$2,277	\$2,697	\$2,906	\$3,116	\$3,326	\$3,536	\$3,746	\$3,956	\$4,165	\$4,375	\$4,585	\$4,795
	Inside: 48W 20D 40.5H S/H 19	ZONE 2	\$2,391	\$2,810	\$3,020	\$3,230	\$3,440	\$3,650	\$3,860	\$4,069	\$4,279	\$4,489	\$4,699	\$4,909
	Yardages: Seat: 1.5 Base: 3/4 Back: 3 Arms: 3	ZONE 3	\$2,505	\$2,924	\$3,134	\$3,344	\$3,554	\$3,764	\$3,973	\$4,183	\$4,393	\$4,603	\$4,813	\$5,023
		ZONE 4	\$2,619	\$3,038	\$3,248	\$3,458	\$3,668	\$3,877	\$4,087	\$4,297	\$4,507	\$4,717	\$4,927	\$5,136
		ZONE 5	\$2,732	\$3,152	\$3,362	\$3,572	\$3,782	\$3,991	\$4,201	\$4,411	\$4,621	\$4,831	\$5,040	\$5,250

Approximate Shipping weight: 120 lbs

GE-330LR		Zone	COM		COL									
High Back Sofa Two Arms	Dimensions/ Yardage	Grade	A	B	C	D	E	F	G	H	I	J	K	L
	Outside: 77W 29D 59.5H	ZONE 1	\$2,615	\$3,124	\$3,378	\$3,633	\$3,887	\$4,142	\$4,396	\$4,651	\$4,905	\$5,160	\$5,414	\$5,669
	Inside: 72W 20D 40.5H S/H 19	ZONE 2	\$2,746	\$3,255	\$3,509	\$3,764	\$4,018	\$4,273	\$4,527	\$4,781	\$5,036	\$5,290	\$5,545	\$5,799
	Yardages: Seat: 2.25 Base: 3/4 Back: 3.75 Arm: 3	ZONE 3	\$2,877	\$3,385	\$3,640	\$3,894	\$4,149	\$4,403	\$4,658	\$4,912	\$5,167	\$5,421	\$5,676	\$5,930
		ZONE 4	\$3,007	\$3,516	\$3,771	\$4,025	\$4,280	\$4,534	\$4,789	\$5,043	\$5,297	\$5,552	\$5,806	\$6,061
		ZONE 5	\$3,138	\$3,647	\$3,901	\$4,156	\$4,410	\$4,665	\$4,919	\$5,174	\$5,428	\$5,683	\$5,937	\$6,192

Approximate Shipping weight: 185 lbs

GE-311		Zone	COM		COL									
High Back 30° Concave	Dimensions/ Yardage	Grade	A	B	C	D	E	F	G	H	I	J	K	L
	Outside: 24-40W 29D 59.5H	ZONE 1	\$2,052	\$2,293	\$2,414	\$2,534	\$2,655	\$2,775	\$2,896	\$3,016	\$3,137	\$3,257	\$3,378	\$3,498
	Inside: 24-38W 20D 40.5H S/H 19	ZONE 2	\$2,155	\$2,396	\$2,516	\$2,637	\$2,757	\$2,878	\$2,998	\$3,119	\$3,239	\$3,360	\$3,480	\$3,601
	Yardages: Seat: 1.5 Base: 1.5 Back: 2.5	ZONE 3	\$2,257	\$2,498	\$2,619	\$2,739	\$2,860	\$2,980	\$3,101	\$3,221	\$3,342	\$3,463	\$3,583	\$3,704
		ZONE 4	\$2,360	\$2,601	\$2,721	\$2,842	\$2,962	\$3,083	\$3,204	\$3,324	\$3,445	\$3,565	\$3,686	\$3,806
		ZONE 5	\$2,462	\$2,703	\$2,824	\$2,945	\$3,065	\$3,186	\$3,306	\$3,427	\$3,547	\$3,668	\$3,788	\$3,909

Approximate Shipping weight: 63 lbs

GE-312		Zone	COM		COL									
High Back 30° Convex	Dimensions/ Yardage	Grade	A	B	C	D	E	F	G	H	I	J	K	L
	Outside: 40-24W 29D 59.5H	ZONE 1	\$2,097	\$2,338	\$2,459	\$2,579	\$2,700	\$2,820	\$2,941	\$3,061	\$3,182	\$3,302	\$3,423	\$3,543
	Inside: 38-24W 20D 40.5H S/H 19	ZONE 2	\$2,307	\$2,548	\$2,668	\$2,789	\$2,909	\$3,030	\$3,150	\$3,271	\$3,392	\$3,512	\$3,633	\$3,753
	Yardages: Seat: 1.5 Base: 1.5 Back: 2.5	ZONE 3	\$2,412	\$2,653	\$2,773	\$2,894	\$3,014	\$3,135	\$3,255	\$3,376	\$3,496	\$3,617	\$3,737	\$3,858
		ZONE 4	\$2,516	\$2,757	\$2,878	\$2,999	\$3,119	\$3,240	\$3,360	\$3,481	\$3,601	\$3,722	\$3,842	\$3,963
		ZONE 5	\$2,642	\$2,883	\$3,004	\$3,125	\$3,246	\$3,367	\$3,488	\$3,609	\$3,730	\$3,851	\$3,972	\$4,093

Approximate Shipping weight: 63 lbs

GEMINI COLLECTION

Seat Construction: Engineered Hardwood

Floating Shelf: Surface- HPL; Core - Medium Density Particle Board

Legs: 140 mm Height Adjustable; Material - Zamak

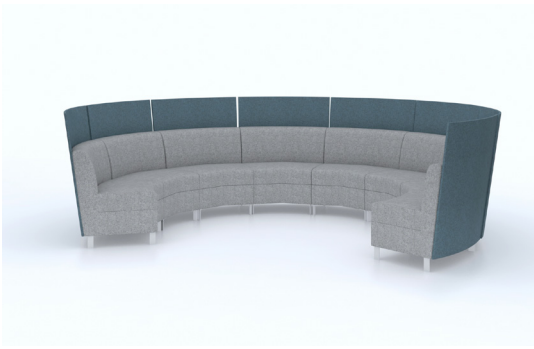

SIN # 711-16

GE-313		Zone	COM		COL									
High Back Corner Chair	Dimensions/ Yardage	Grade	A	B	C	D	E	F	G	H	I	J	K	L
	Outside: 37.5W 37.5D 59.5H Inside: 30W 30D 40.5H S/H 19 Yardages: Seat: 1.75 Base 3/4 Back: 3.75	ZONE 1	\$1,939	\$2,180	\$2,301	\$2,421	\$2,542	\$2,662	\$2,783	\$2,903	\$3,024	\$3,144	\$3,265	\$3,385
		ZONE 2	\$2,036	\$2,277	\$2,398	\$2,518	\$2,639	\$2,759	\$2,880	\$3,000	\$3,121	\$3,241	\$3,362	\$3,482
		ZONE 3	\$2,133	\$2,374	\$2,495	\$2,615	\$2,736	\$2,856	\$2,977	\$3,097	\$3,218	\$3,338	\$3,459	\$3,579
		ZONE 4	\$2,230	\$2,471	\$2,591	\$2,712	\$2,833	\$2,953	\$3,074	\$3,194	\$3,315	\$3,435	\$3,556	\$3,676
		ZONE 5	\$2,327	\$2,568	\$2,688	\$2,809	\$2,929	\$3,050	\$3,171	\$3,291	\$3,412	\$3,532	\$3,653	\$3,773

Approximate Shipping weight: 81 lbs

GE-310-S		Zone	COM		COL									
High Back Lounge w/ Floating Shelf	Dimensions/ Yardage	Grade	A	B	C	D	E	F	G	H	I	J	K	L
	Outside: 24W 41D 59.5H Inside: 24W 20D 40.5H S/H 19 Yardages: Seat: 1 Base: 1/2 Back: 2	ZONE 1	\$1,917	\$2,078	\$2,158	\$2,238	\$2,319	\$2,399	\$2,480	\$2,560	\$2,640	\$2,721	\$2,801	\$2,881
		ZONE 2	\$2,013	\$2,174	\$2,254	\$2,334	\$2,415	\$2,495	\$2,575	\$2,656	\$2,736	\$2,816	\$2,897	\$2,977
		ZONE 3	\$2,109	\$2,269	\$2,350	\$2,430	\$2,510	\$2,591	\$2,671	\$2,752	\$2,832	\$2,912	\$2,993	\$3,073
		ZONE 4	\$2,205	\$2,365	\$2,446	\$2,526	\$2,606	\$2,687	\$2,767	\$2,847	\$2,928	\$3,008	\$3,088	\$3,169
		ZONE 5	\$2,300	\$2,461	\$2,541	\$2,622	\$2,702	\$2,783	\$2,863	\$2,943	\$3,024	\$3,104	\$3,184	\$3,265

Approximate Shipping weight: 88 lbs

GE-320-S		Zone	COM		COL									
High Back Love seat w/ Floating Shelf	Dimensions/ Yardage	Grade	A	B	C	D	E	F	G	H	I	J	K	L
	Outside: 48W 41D 59.5H Inside: 48W 20D 40.5H S/H 19 Yardages: Seat: 1.5 Base: 3/4 Back: 3	ZONE 1	\$2,676	\$2,899	\$3,011	\$3,122	\$3,234	\$3,346	\$3,457	\$3,569	\$3,680	\$3,792	\$3,904	\$4,015
		ZONE 2	\$2,810	\$3,033	\$3,145	\$3,256	\$3,368	\$3,479	\$3,591	\$3,703	\$3,814	\$3,926	\$4,037	\$4,149
		ZONE 3	\$2,944	\$3,167	\$3,278	\$3,390	\$3,502	\$3,613	\$3,725	\$3,836	\$3,948	\$4,060	\$4,171	\$4,283
		ZONE 4	\$3,077	\$3,301	\$3,412	\$3,524	\$3,635	\$3,747	\$3,859	\$3,970	\$4,082	\$4,193	\$4,305	\$4,417
		ZONE 5	\$3,211	\$3,434	\$3,546	\$3,658	\$3,769	\$3,881	\$3,992	\$4,104	\$4,216	\$4,327	\$4,439	\$4,550

Approximate Shipping weight: 156 lbs

GE-330-S		Zone	COM		COL									
High Back Sofa w/ Floating Shelf	Dimensions/ Yardage	Grade	A	B	C	D	E	F	G	H	I	J	K	L
	Outside: 72W 41D 59.5H Inside: 72W 20D 40.5H S/H 19 Yardages: Seat: 2.25 Base: 3/4 Back: 3.75	ZONE 1	\$3,133	\$3,446	\$3,602	\$3,758	\$3,914	\$4,071	\$4,227	\$4,383	\$4,539	\$4,696	\$4,852	\$5,008
		ZONE 2	\$3,446	\$3,759	\$3,915	\$4,071	\$4,228	\$4,384	\$4,540	\$4,696	\$4,853	\$5,009	\$5,165	\$5,321
		ZONE 3	\$3,603	\$3,915	\$4,072	\$4,228	\$4,384	\$4,540	\$4,697	\$4,853	\$5,009	\$5,165	\$5,322	\$5,478
		ZONE 4	\$3,760	\$4,072	\$4,228	\$4,385	\$4,541	\$4,697	\$4,853	\$5,010	\$5,166	\$5,322	\$5,478	\$5,635
		ZONE 5	\$3,948	\$4,260	\$4,416	\$4,572	\$4,728	\$4,884	\$5,040	\$5,196	\$5,352	\$5,508	\$5,664	\$5,820

Approximate Shipping weight: 219 lbs

GEMINI COLLECTION

Seat Construction: Engineered Hardwood

Floating Shelf: Surface- HPL; Core - Medium Density Particle Board

Legs: 140 mm Height Adjustable; Material - Zamak



SIN # 711-16

GE-310R-S														
High Back Lounge Left Arm Sitting w/ Floating Shelf	Dimensions/ Yardage	Zone Grade	COM A	B	COL C	D	E	F	G	H	I	J	K	L
	Outside: 26.5W 41D 59.5H	ZONE 1	\$2,115	\$2,374	\$2,503	\$2,633	\$2,762	\$2,892	\$3,021	\$3,151	\$3,280	\$3,410	\$3,539	\$3,669
	Inside: 24W 20D 40.5H	ZONE 2	\$2,221	\$2,480	\$2,609	\$2,739	\$2,868	\$2,998	\$3,127	\$3,256	\$3,386	\$3,515	\$3,645	\$3,774
	S/H 19 A/H	ZONE 3	\$2,327	\$2,585	\$2,715	\$2,844	\$2,974	\$3,103	\$3,233	\$3,362	\$3,492	\$3,621	\$3,751	\$3,880
	Yardages: Seat: 1 Base: 1/2	ZONE 4	\$2,432	\$2,691	\$2,821	\$2,950	\$3,080	\$3,209	\$3,339	\$3,468	\$3,597	\$3,727	\$3,856	\$3,986
	Back: 2 Arm: 1.5	ZONE 5	\$2,538	\$2,797	\$2,926	\$3,056	\$3,185	\$3,315	\$3,444	\$3,574	\$3,703	\$3,833	\$3,962	\$4,092

Approximate Shipping weight: 98 lbs

GE-310L-S														
High Back Lounge Right Arm Sitting w/ Floating Shelf	Dimensions/ Yardage	Zone Grade	COM A	B	COL C	D	E	F	G	H	I	J	K	L
	Outside: 26.5W 41D 59.5H	ZONE 1	\$2,115	\$2,374	\$2,503	\$2,633	\$2,762	\$2,892	\$3,021	\$3,151	\$3,280	\$3,410	\$3,539	\$3,669
	Inside: 24W 20D 40.5H	ZONE 2	\$2,221	\$2,480	\$2,609	\$2,739	\$2,868	\$2,998	\$3,127	\$3,256	\$3,386	\$3,515	\$3,645	\$3,774
	S/H 19 A/H	ZONE 3	\$2,327	\$2,585	\$2,715	\$2,844	\$2,974	\$3,103	\$3,233	\$3,362	\$3,492	\$3,621	\$3,751	\$3,880
	Yardages: Seat: 1 Base: 1/2	ZONE 4	\$2,432	\$2,691	\$2,821	\$2,950	\$3,080	\$3,209	\$3,339	\$3,468	\$3,597	\$3,727	\$3,856	\$3,986
	Back: 2 Arm: 1.5	ZONE 5	\$2,538	\$2,797	\$2,926	\$3,056	\$3,185	\$3,315	\$3,444	\$3,574	\$3,703	\$3,833	\$3,962	\$4,092

Approximate Shipping weight: 98 lbs

GE-320L-S														
High Back Love Seat Left Arm Sitting w/ Floating Shelf	Dimensions/ Yardage	Zone Grade	COM A	B	COL C	D	E	F	G	H	I	J	K	L
	Outside: 50.5W 41D 59.5H	ZONE 1	\$2,875	\$3,196	\$3,357	\$3,518	\$3,679	\$3,839	\$4,000	\$4,161	\$4,321	\$4,482	\$4,643	\$4,804
	Inside: 48W 20D 40.5H	ZONE 2	\$3,019	\$3,340	\$3,501	\$3,662	\$3,822	\$3,983	\$4,144	\$4,304	\$4,465	\$4,626	\$4,787	\$4,947
	S/H 19	ZONE 3	\$3,163	\$3,484	\$3,645	\$3,805	\$3,966	\$4,127	\$4,288	\$4,448	\$4,609	\$4,770	\$4,930	\$5,091
	Yardages: Seat: 1.5 Base: 3/4	ZONE 4	\$3,306	\$3,628	\$3,788	\$3,949	\$4,110	\$4,271	\$4,431	\$4,592	\$4,753	\$4,913	\$5,074	\$5,235
	Back: 3 Arm: 1.5	ZONE 5	\$3,450	\$3,771	\$3,932	\$4,093	\$4,254	\$4,414	\$4,575	\$4,736	\$4,896	\$5,057	\$5,218	\$5,379

Approximate Shipping weight: 166 lbs

GE-320R-S														
High Back Love Seat Right Arm Sitting w/ Floating Shelf	Dimensions/ Yardage	Zone Grade	COM A	B	COL C	D	E	F	G	H	I	J	K	L
	Outside: 50.5W 41D 59.5H	ZONE 1	\$2,875	\$3,196	\$3,357	\$3,518	\$3,679	\$3,839	\$4,000	\$4,161	\$4,321	\$4,482	\$4,643	\$4,804
	Inside: 48W 20D 40.5H	ZONE 2	\$3,019	\$3,340	\$3,501	\$3,662	\$3,822	\$3,983	\$4,144	\$4,304	\$4,465	\$4,626	\$4,787	\$4,947
	S/H 19	ZONE 3	\$3,163	\$3,484	\$3,645	\$3,805	\$3,966	\$4,127	\$4,288	\$4,448	\$4,609	\$4,770	\$4,930	\$5,091
	Yardages: Seat: 1.5 Base: 3/4	ZONE 4	\$3,306	\$3,628	\$3,788	\$3,949	\$4,110	\$4,271	\$4,431	\$4,592	\$4,753	\$4,913	\$5,074	\$5,235
	Back: 3 Arm: 1.5	ZONE 5	\$3,450	\$3,771	\$3,932	\$4,093	\$4,254	\$4,414	\$4,575	\$4,736	\$4,896	\$5,057	\$5,218	\$5,379

Approximate Shipping weight: 166 lbs

GEMINI COLLECTION

Seat Construction: Engineered Hardwood

Floating Shelf: Surface- HPL; Core - Medium Density Particle Board

Legs: 140 mm Height Adjustable; Material - Zamak

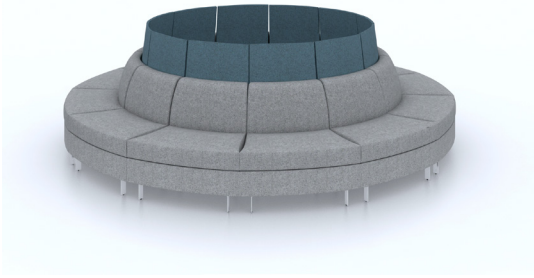

SIN # 711-16

GE-330L-S														
High Back Sofa Left Arm Sitting w/ Floating Shelf	Dimensions/ Yardage	Zone Grade	COM A	B	COL C	D	E	F	G	H	I	J	K	L
	Outside: 74.5W 41D 59.5H	ZONE 1	\$3,332	\$3,743	\$3,948	\$4,153	\$4,359	\$4,564	\$4,770	\$4,975	\$5,180	\$5,386	\$5,591	\$5,796
	Inside: 72W 20D 40.5H S/H 19	ZONE 2	\$3,499	\$3,909	\$4,115	\$4,320	\$4,525	\$4,731	\$4,936	\$5,141	\$5,347	\$5,552	\$5,758	\$5,963
	Yardages: Seat: 2.25 Base: 3/4 Back: 3.75 Arm: 1.5	ZONE 3	\$3,665	\$4,076	\$4,281	\$4,487	\$4,692	\$4,897	\$5,103	\$5,308	\$5,513	\$5,719	\$5,924	\$6,129
		ZONE 4	\$3,832	\$4,243	\$4,448	\$4,653	\$4,859	\$5,064	\$5,269	\$5,475	\$5,680	\$5,885	\$6,091	\$6,296
		ZONE 5	\$3,998	\$4,409	\$4,614	\$4,820	\$5,025	\$5,231	\$5,436	\$5,641	\$5,847	\$6,052	\$6,257	\$6,463

Approximate Shipping weight: 229 lbs

GE-330R-S														
High Back Sofa Right Arm Sitting w/ Floating Shelf	Dimensions/ Yardage	Zone Grade	COM A	B	COL C	D	E	F	G	H	I	J	K	L
	Outside: 74.5W 41D 59.5H	ZONE 1	\$3,332	\$3,743	\$3,948	\$4,153	\$4,359	\$4,564	\$4,770	\$4,975	\$5,180	\$5,386	\$5,591	\$5,796
	Inside: 72W 20D 40.5H S/H 19	ZONE 2	\$3,499	\$3,909	\$4,115	\$4,320	\$4,525	\$4,731	\$4,936	\$5,141	\$5,347	\$5,552	\$5,758	\$5,963
	Yardages: Seat: 2.25 Base: 3/4 Back: 3.75 Arm: 1.5	ZONE 3	\$3,665	\$4,076	\$4,281	\$4,487	\$4,692	\$4,897	\$5,103	\$5,308	\$5,513	\$5,719	\$5,924	\$6,129
		ZONE 4	\$3,832	\$4,243	\$4,448	\$4,653	\$4,859	\$5,064	\$5,269	\$5,475	\$5,680	\$5,885	\$6,091	\$6,296
		ZONE 5	\$3,998	\$4,409	\$4,614	\$4,820	\$5,025	\$5,231	\$5,436	\$5,641	\$5,847	\$6,052	\$6,257	\$6,463

Approximate Shipping weight: 229 lbs

GE-310LR-S														
High Back Lounge Two Arms w/ Floating Shelf	Dimensions/ Yardage	Zone Grade	COM A	B	COL C	D	E	F	G	H	I	J	K	L
	Outside: 29W 41D 59.5H	ZONE 1	\$2,314	\$2,671	\$2,850	\$3,028	\$3,207	\$3,385	\$3,564	\$3,743	\$3,921	\$4,100	\$4,278	\$4,457
	Inside: 24W 20D 40.5H S/H 19	ZONE 2	\$2,545	\$2,903	\$3,081	\$3,260	\$3,438	\$3,617	\$3,795	\$3,974	\$4,153	\$4,331	\$4,510	\$4,688
	Yardages: Seat: 1 Base: 1/2 Back: 2 Arms: 3	ZONE 3	\$2,661	\$3,018	\$3,197	\$3,375	\$3,554	\$3,733	\$3,911	\$4,090	\$4,268	\$4,447	\$4,625	\$4,804
		ZONE 4	\$2,777	\$3,134	\$3,313	\$3,491	\$3,670	\$3,848	\$4,027	\$4,205	\$4,384	\$4,563	\$4,741	\$4,920
		ZONE 5	\$2,915	\$3,280	\$3,459	\$3,638	\$3,817	\$3,996	\$4,175	\$4,354	\$4,533	\$4,712	\$4,891	\$5,070

Approximate Shipping weight: 108 lbs

GE-320LR-S														
High Back Love Seat Two Arms w/ Floating Shelf	Dimensions/ Yardage	Zone Grade	COM A	B	COL C	D	E	F	G	H	I	J	K	L
	Outside: 53W 41D 59.5H	ZONE 1	\$3,074	\$3,494	\$3,703	\$3,913	\$4,123	\$4,333	\$4,543	\$4,753	\$4,962	\$5,172	\$5,382	\$5,592
	Inside: 48W 20D 40.5H S/H 19	ZONE 2	\$3,228	\$3,647	\$3,857	\$4,067	\$4,277	\$4,487	\$4,696	\$4,906	\$5,116	\$5,326	\$5,536	\$5,746
	Yardages: Seat: 1.5 Base: 3/4 Back: 3 Arms: 3	ZONE 3	\$3,381	\$3,801	\$4,011	\$4,221	\$4,431	\$4,640	\$4,850	\$5,060	\$5,270	\$5,480	\$5,689	\$5,899
		ZONE 4	\$3,535	\$3,955	\$4,165	\$4,374	\$4,584	\$4,794	\$5,004	\$5,214	\$5,423	\$5,633	\$5,843	\$6,053
		ZONE 5	\$3,689	\$4,108	\$4,318	\$4,528	\$4,738	\$4,948	\$5,158	\$5,367	\$5,577	\$5,787	\$5,997	\$6,207

Approximate Shipping weight: 176 lbs

GEMINI COLLECTION

Seat Construction: Engineered Hardwood

Floating Shelf: Surface- HPL; Core - Medium Density Particle Board

Legs: 140 mm Height Adjustable; Material - Zamak



SIN # 711-16

GE-330LR-S														
High Back Sofa Two Arms w/ Floating Shelf	Dimensions/ Yardage	Zone Grade	COM A	B	COL C	D	E	F	G	H	I	J	K	L
	Outside: 77W 41D 59.5H	ZONE 1	\$3,530	\$4,039	\$4,293	\$4,548	\$4,802	\$5,057	\$5,311	\$5,566	\$5,820	\$6,075	\$6,329	\$6,584
	Inside: 72W 20D 40.5H S/H 19	ZONE 2	\$3,707	\$4,215	\$4,470	\$4,724	\$4,979	\$5,233	\$5,488	\$5,742	\$5,997	\$6,251	\$6,506	\$6,760
	Yardages: Seat: 2.25 Base: 3/4 Back: 3.75 Arm: 3	ZONE 3	\$3,883	\$4,392	\$4,646	\$4,901	\$5,155	\$5,410	\$5,664	\$5,919	\$6,173	\$6,428	\$6,682	\$6,937
		ZONE 4	\$4,060	\$4,568	\$4,823	\$5,077	\$5,332	\$5,586	\$5,841	\$6,095	\$6,350	\$6,604	\$6,859	\$7,113
		ZONE 5	\$4,236	\$4,745	\$4,999	\$5,254	\$5,508	\$5,763	\$6,017	\$6,272	\$6,526	\$6,781	\$7,035	\$7,290

Approximate Shipping weight: 239 lbs

GE-311-S														
High Back 30° Concave w/ Floating Shelf	Dimensions/ Yardage	Zone Grade	COM A	B	COL C	D	E	F	G	H	I	J	K	L
	Outside: 24-40W 41D 59.5H	ZONE 1	\$2,771	\$3,012	\$3,133	\$3,253	\$3,374	\$3,494	\$3,615	\$3,735	\$3,856	\$3,976	\$4,097	\$4,217
	Inside: 24-38W 20D 40.5H S/H 19	ZONE 2	\$2,910	\$3,151	\$3,271	\$3,392	\$3,512	\$3,633	\$3,753	\$3,874	\$3,994	\$4,115	\$4,235	\$4,356
	Yardages: Seat: 1.5 Base: 1.5 Back: 2.5	ZONE 3	\$3,048	\$3,289	\$3,410	\$3,530	\$3,651	\$3,771	\$3,892	\$4,012	\$4,133	\$4,253	\$4,374	\$4,495
		ZONE 4	\$3,187	\$3,428	\$3,548	\$3,669	\$3,789	\$3,910	\$4,030	\$4,151	\$4,271	\$4,392	\$4,513	\$4,633
		ZONE 5	\$3,325	\$3,566	\$3,687	\$3,807	\$3,928	\$4,048	\$4,169	\$4,289	\$4,410	\$4,531	\$4,651	\$4,772

Approximate Shipping weight: 88 lbs

GE-312-S														
High Back 30° Convex w/ Floating Shelf	Dimensions/ Yardage	Zone Grade	COM A	B	COL C	D	E	F	G	H	I	J	K	L
	Outside: 40-24W 41D 59.5H	ZONE 1	\$2,830	\$3,071	\$3,192	\$3,312	\$3,433	\$3,553	\$3,674	\$3,794	\$3,915	\$4,035	\$4,156	\$4,276
	Inside: 38-24W 20D 40.5H S/H 19	ZONE 2	\$2,972	\$3,213	\$3,333	\$3,454	\$3,574	\$3,695	\$3,815	\$3,936	\$4,056	\$4,177	\$4,297	\$4,418
	Yardages: Seat: 1.5 Base: 1.5 Back: 2.5	ZONE 3	\$3,113	\$3,354	\$3,475	\$3,595	\$3,716	\$3,836	\$3,957	\$4,077	\$4,198	\$4,318	\$4,439	\$4,559
		ZONE 4	\$3,255	\$3,496	\$3,616	\$3,737	\$3,857	\$3,978	\$4,098	\$4,219	\$4,339	\$4,460	\$4,580	\$4,701
		ZONE 5	\$3,396	\$3,637	\$3,758	\$3,878	\$3,999	\$4,119	\$4,240	\$4,360	\$4,481	\$4,601	\$4,722	\$4,842

Approximate Shipping weight: 88 lbs

GE-313-S														
High Back Corner Chair w/ Floating Shelf	Dimensions/ Yardage	Zone Grade	COM A	B	COL C	D	E	F	G	H	I	J	K	L
	Outside: 37.5W 37.5D 59.5H	ZONE 1	\$2,618	\$2,859	\$2,980	\$3,100	\$3,221	\$3,341	\$3,462	\$3,582	\$3,703	\$3,823	\$3,944	\$4,064
	Inside: 30W 30D 40.5H S/H 19	ZONE 2	\$2,749	\$2,990	\$3,111	\$3,231	\$3,352	\$3,472	\$3,593	\$3,713	\$3,834	\$3,954	\$4,075	\$4,195
	Yardages: Seat: 1.75 Base 3/4 Back: 3.75	ZONE 3	\$2,880	\$3,121	\$3,241	\$3,362	\$3,482	\$3,603	\$3,724	\$3,844	\$3,965	\$4,085	\$4,206	\$4,326
		ZONE 4	\$3,011	\$3,252	\$3,372	\$3,493	\$3,613	\$3,734	\$3,854	\$3,975	\$4,096	\$4,216	\$4,337	\$4,457
		ZONE 5	\$3,142	\$3,383	\$3,503	\$3,624	\$3,744	\$3,865	\$3,985	\$4,106	\$4,226	\$4,347	\$4,467	\$4,588

Approximate Shipping weight: 116 lbs

GEMINI COLLECTION

Seat Construction: Engineered Hardwood

Floating Shelf: Surface- HPL; Core - Medium Density Particle Board

Legs: 140 mm Height Adjustable; Material - Zamak



SIN # 711-16

GE-110 Bench	Dimensions/ Yardage	Zone Grade	COM A	B	COL C	D	E	F	G	H	I	J	K	L
	Outside: 24W 29D 19H	ZONE 1	\$927	\$1,016	\$1,061	\$1,106	\$1,150	\$1,195	\$1,240	\$1,284	\$1,329	\$1,373	\$1,418	\$1,463
		ZONE 2	\$973	\$1,063	\$1,107	\$1,152	\$1,197	\$1,241	\$1,286	\$1,330	\$1,375	\$1,420	\$1,464	\$1,509
	Yardages: Seat: 1 Base: 1/2	ZONE 3	\$1,020	\$1,109	\$1,154	\$1,198	\$1,243	\$1,288	\$1,332	\$1,377	\$1,421	\$1,466	\$1,511	\$1,555
		ZONE 4	\$1,066	\$1,155	\$1,200	\$1,245	\$1,289	\$1,334	\$1,379	\$1,423	\$1,468	\$1,512	\$1,557	\$1,602
		ZONE 5	\$1,112	\$1,202	\$1,246	\$1,291	\$1,336	\$1,380	\$1,425	\$1,470	\$1,514	\$1,559	\$1,603	\$1,648

Approximate Shipping weight: 30 lbs

GE-111 30° Concave Bench	Dimensions/ Yardage	Zone Grade	COM A	B	COL C	D	E	F	G	H	I	J	K	L
	Outside: 24-40W 29D 19H	ZONE 1	\$1,033	\$1,131	\$1,180	\$1,229	\$1,279	\$1,328	\$1,377	\$1,426	\$1,475	\$1,524	\$1,573	\$1,622
		ZONE 2	\$1,085	\$1,183	\$1,232	\$1,281	\$1,330	\$1,379	\$1,428	\$1,478	\$1,527	\$1,576	\$1,625	\$1,674
	Yardages: Seat: 1.5 Base: 1.5	ZONE 3	\$1,136	\$1,235	\$1,284	\$1,333	\$1,382	\$1,431	\$1,480	\$1,529	\$1,578	\$1,627	\$1,676	\$1,726
		ZONE 4	\$1,188	\$1,286	\$1,335	\$1,384	\$1,433	\$1,483	\$1,532	\$1,581	\$1,630	\$1,679	\$1,728	\$1,777
		ZONE 5	\$1,240	\$1,338	\$1,387	\$1,436	\$1,485	\$1,534	\$1,583	\$1,632	\$1,682	\$1,731	\$1,780	\$1,829

Approximate Shipping weight: 35 lbs

GE-112 30° Convex Bench	Dimensions/ Yardage	Zone Grade	COM A	B	COL C	D	E	F	G	H	I	J	K	L
	Outside: 40-24W 29D 19H	ZONE 1	\$1,033	\$1,131	\$1,180	\$1,229	\$1,279	\$1,328	\$1,377	\$1,426	\$1,475	\$1,524	\$1,573	\$1,622
		ZONE 2	\$1,085	\$1,183	\$1,232	\$1,281	\$1,330	\$1,379	\$1,428	\$1,478	\$1,527	\$1,576	\$1,625	\$1,674
	Yardages: Seat: 1.5 Base: 1.5	ZONE 3	\$1,136	\$1,235	\$1,284	\$1,333	\$1,382	\$1,431	\$1,480	\$1,529	\$1,578	\$1,627	\$1,676	\$1,726
		ZONE 4	\$1,188	\$1,286	\$1,335	\$1,384	\$1,433	\$1,483	\$1,532	\$1,581	\$1,630	\$1,679	\$1,728	\$1,777
		ZONE 5	\$1,240	\$1,338	\$1,387	\$1,436	\$1,485	\$1,534	\$1,583	\$1,632	\$1,682	\$1,731	\$1,780	\$1,829

Approximate Shipping weight: 35 lbs

Options | Accessories

Contrasting Fabrics: +50\$ LIST per Fabric

Leg Colors:

Aluminum



Chrome



Dark Brown



Casters:

Front (-CASF)



+ \$350 LIST

Rear (-CASR)



+ \$350 LIST

Four (-CAS4)



+ \$700 LIST

Laminate Options: (For Floating Shelves)

<http://hickorycontract.com/wp-content/uploads/2018/01/Hickory-Contract-Standard-Laminates-2018-.pdf>

Electrical: The following electrical units are available in the Left or Right bottom middle of the side of the base/arm of any model

Black 2 Power

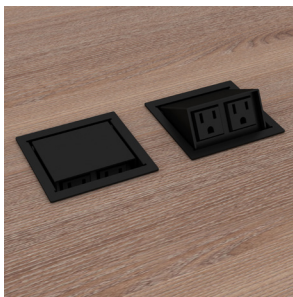

Silver Pearl 2 Power



Black 1 Power 1 USB



Silver Pearl 1 Power 1 USB



+ \$375 LIST



+ \$375 LIST



+ \$425 LIST



+ \$425 LIST

Options | Accessories

Electrical: For Floating Shelves. Circular or Square USB Charger **+\$400 LIST**

Black



White



Gray



Chrome



Ganging Brackets: +\$FREE

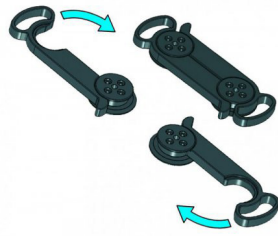

- Easily connected or disconnected by using integral handle
- 360 degrees of connectivity

PRODUCT SPECIFICATIONS

Our wood lounge frames are bench made exclusively in North Carolina by local craftsmen who have been building furniture in this area for generations. We use only kiln-dried Beech or beech hardwood (5/4 size minimum) or durable engineered wood panels crafted of multilayered solid wood veneers to reduce movement, twisting and warping. Key joints are reinforced with traditional double dowels, corner blocks and interlocking joints to withstand weight and stress. Exposed wood furnishings are handcrafted of the finest Beech or beech hardwoods. Rails are double doweled and corner blocked for maximum strength. All corner blocks are screwed and/or stapled to insure strength.

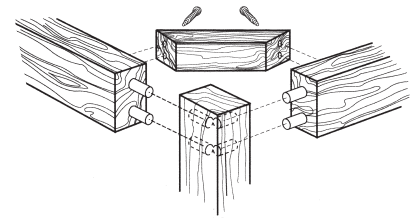

SPRING AND SEAT CONSTRUCTION

HC's primary spring and seat construction is the eight-way hand tied system. When eight-way construction is not possible due to design HC will use an appropriate seat construction based on industry standards.

- **Eight-Way Hand Tied System**

The best spring construction available when chair design allows. Provides comfort and long life by utilizing double coil springs tied to each other and frame rails. This allows springs to move only in a vertical motion and distribute weight load equally to chair rails.

Materials

- Eight and nine gauge solid carbon steel double coil springs.
- 100% waxed #6 nylon string.
- Eight knots per coil at top.
- Paper lined steel fastener secures coil to bottom.
- 54 strands/inch #650 Woven Poly Propex bottom.
- 7/8" steel nails attach strings to rails.
- System covered with FLW Polywoven material.

- **Rubber Webbing System**

Simple spring construction for Contemporary and Transitional seating that require very thin scaled designs. Provides comfort and strength by attaching rubber webbing from the front rail to the back rail and across seat from side rails.

Materials

- Ultraflex Type #550 rubber webbing 2" wide with 20% stretch load
- #10 steel staples attach webbing to frame rails.

- **No Sag System**

The best spring construction for designs that do not allow for eight way hand tied system. Used on most Contemporary and Transitional style seating and as a cost savings on Traditional style seating. Provides comfort and strength by using sinuous wire springs that are connected to front and back rails. These springs are then held together by a coated wire clipped to each spring.

Materials

- Eight and ten gauge sinuous wire springs in continuous 2" wide loops. These springs are spread 4" on center across seat.
- Coated stabilizing wire.
- System covered with FLW Polywoven material.

- **Foam Over Propex**

Simple seat construction for Contemporary and Transitional seating that require very thin scaled designs. Provides comfort and strength by attaching Polywoven propex material to all four side rails then covering with foam.

Materials

- #650 woven poly propex with 54 strands per sq. inch
- 500 7/16" steel staples attach propex to rails.

MECHANISMS

- **Manual Swivel Tilt Control** - Used for medium and large fixed back tilting chairs this spring control employs a low fulcrum and a dual "floating spring" concept to ensure both a balanced and stable ride throughout the full tilting range. Nylon contacts rubber cushion shock absorbers and self-lubricating fiberglass reinforced nylon bearings provide for long lasting quality.

Adjustments: A. Tilt tension control knob
B. Manual height adjustment

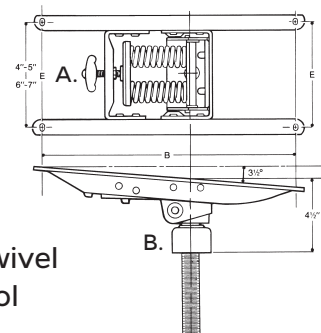

Typical Swivel
Tilt Control

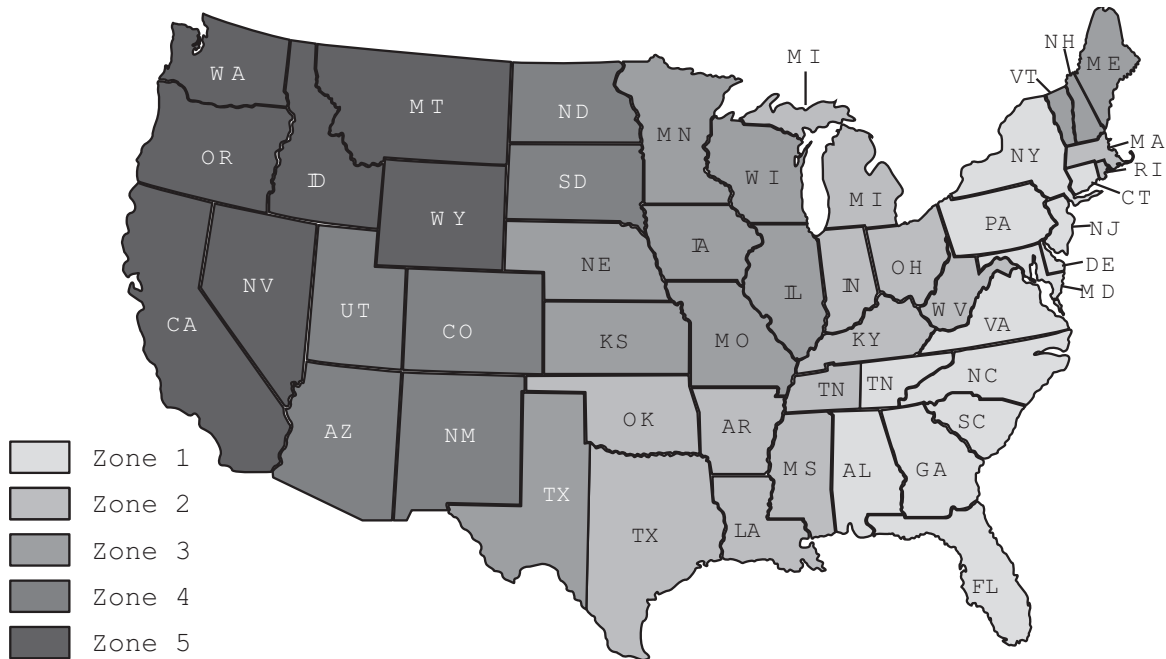

ZONE 1

- ALABAMA
- CONNECTICUT
- DELAWARE
- DISTRICT OF COLUMBIA
- FLORIDA
- GEORGIA
- MARYLAND
- NEW JERSEY
- NEW YORK
- NORTH CAROLINA
- PENNSYLVANIA
- SOUTH CAROLINA
- TENNESSEE (EAST)
- VIRGINIA

ZONE 2

- ARKANSAS
- INDIANA
- KENTUCKY
- LOUISIANA
- MASSACHUSETTS
- MICHIGAN
- MISSISSIPPI
- OHIO
- OKLAHOMA
- RHODE ISLAND
- WEST VIRGINIA
- TENNESSEE (WEST)
- TEXAS (EAST)

ZONE 3

- ILLINOIS
- IOWA
- KANSAS
- MAINE
- MINNESOTA
- MISSOURI
- NEBRASKA
- NEW HAMPSHIRE
- VERMONT
- WISCONSIN
- TEXAS (WEST)

ZONE 4

- ARIZONA
- COLORADO
- NEW MEXICO
- NORTH DAKOTA
- SOUTH DAKOTA
- UTAH

ZONE 5

- CALIFORNIA
- IDAHO
- MONTANA
- NEVADA
- OREGON
- WASHINGTON
- WYOMING

1. All list prices are F.O.B.- Factory freight prepaid and allowed to one destination. All orders are priced according to the zones listed above. The zone is determined by the “ship to” destination. All prices listed are for shipments within the continental United States. Export and shipments to Alaska and Hawaii are freight prepaid and allowed to port of exit.
2. HC reserves the right to select the appropriate carrier for all shipments.
3. Special requests including but not limited to inside delivery residential delivery installation and call before delivery are not included in prices shown and are the responsibility of the dealer.
4. Any charges arising from failure to meet shipment rerouting

while in transit or carrier storage charges are the responsibility of the dealer.

5. Orders of less than 150 lbs. will be assessed a per order NET handling charge. This charge will be waived for items shipped via UPS.

Zone 1	- \$55	Zone 4	- \$80
Zone 2 & 3	- \$65	Zone 5	- \$95

6. HC will make every effort to ship orders complete but reserves the right to part ship when necessary.

TRANSPORTATION CLAIMS

All furniture is carefully inspected and cartoned according to trucking and railroad requirements. The transportation company assumes full responsibility upon acceptance of the shipment. If shipment arrives damaged:

- Note any visible loss or damage on freight bill
- In case of concealed loss or damage notify transportation company immediately and file “Concealed Damage” claim. This should be done within 5 days of receipt of furniture.
- Be sure to retain the carton and packaging for inspection because the carton may not show outside damage.
- Take photos of damage and notify HC.

GENERAL

All orders must be made in writing; faxed to 704.462.2672, mailed to: HC 7514 West NC #10 Hwy Vale NC 28168 or emailed to info@hlc-usa.com.

Possession of this price list does not constitute an offer to sell.

Orders can only be received from Authorized HC Dealers.

Prices shown in this price list are subject to change without notice. Should a typographical error be found HC reserves the right to make changes.

All Dimensions/s shown in this price list are approximate and subject to variation.

TERMS

NET 30 DAYS. Please make payments for HC invoices to HC. All new account orders must be submitted to HC for approval. HC suggests current financial information for new customers to accompany their initial order to avoid approval delays. Allow two to three weeks for the credit approval process.

A 50% deposit payable to HC with your first order will expedite your shipment while credit is being established. All custom orders will require a 50% deposit payable to HC with the order.

ACKNOWLEDGEMENTS

Order acknowledgments will be made for each order and will indicate final production specifications. Buyers should check acknowledgments to be sure that all order details are correct. Orders will not be acknowledged or entered for production until all specification information is complete. Accepted orders are subject to terms and conditions set forth in this price list and on our acknowledgment. This supersedes any variance in terms and conditions on buyer's purchase order.

HC is not liable for any delays or failure to deliver or perform due to fires floods accidents transportation difficulties failure due to delay of sources of supply acts of God or any other causes of like or unlike nature beyond HC's control.

WAREHOUSING

As production space is at a premium orders will be shipped when completed. Any date other than such date must be approved by the factory. If an order is required to be warehoused due to buyer's request a charge will be levied for such (chairs and ottomans - \$20 list per week lounge chairs love seats and sofas - \$45 list per week). All orders being warehoused will be invoiced at normal time of shipping and paid for under normal terms and conditions. Failure of such could affect credit line.

PRODUCT SPECIFICATIONS

DESIGN

HC reserves the right to make changes in design or construction detail without notice; therefore if it is desired that an order match an order previously shipped it must be clearly stated on your purchase order.

MODIFICATIONS/CUSTOMS

HC has the ability to modify existing products and/or manufacture custom products. Please contact factory for information. This includes OEM Products Frames and Parts. All non-standard HC products have a one year limited warranty. Custom orders require a 50% deposit at time of order placement.

FRAME CONSTRUCTION

CANCELLATION

Any order cancelled after it has been placed into production will be subject to a cancellation charge. This charge will be determined by HC based upon where the order is in production at time of cancellation request.

HC will make every effort to meet acknowledged shipping dates. However failure to meet such a date is not cause for cancellation.

WARRANTY

HC warrants to the original buyer that each piece of HC product will be free from defects in workmanship given normal use and care for ten years of single shift service except where noted in this price list.

HC assumes no responsibility for improper assembly modification abuse alteration negligent use or unauthorized repair work by the buyer.

This warranty does not cover: damage caused by a carrier; C.O.M. or C.O.L; gas cylinder-pneumatic lifts casters and mechanisms beyond the OEM warranty; color grain or texture of woods and other covering materials due to natural variations over which HC has no control.

HC does not offer warranty on textiles beyond what is offered by the supplier.

HC will either replace or repair at our option any parts of the product found to be defective within the terms of warranty. Such is the buyer's sole remedy. HC shall not be liable for consequential or incidental damage to persons or property.

Except as stated herein HC makes no expressed or implied warranties of merchantability or fitness of any HC product for any particular purpose.

All non-standard HC products have a one year limited warranty. All repair charges must be authorized in writing by HC for warranty work. Only after receipt of repair bill from party performing repairs will a credit or reimbursement take place. Do not return any merchandise without written permission from HC. Only warranted product will be considered.

Light finishes tend to highlight rather than mask the natural characteristics and color variation of wood which are not considered defects by HC. Likewise leather is characterized by variation in color from hide to hide and within hides and should be expected. Healed scars scratches insect bites and wrinkles are not considered defects in the leather.

WARNING

Direct sunlight can fade finishes leathers and upholstery; and can dry out leather and degrade some vinyl covers. HC cannot control nor be held responsible for sunlight damage.

PRODUCT SPECIFICATIONS

MECHANISMS (continued)

- Knee Tilt Controls - Used for fixed back tilting chairs the forward positioning of the fulcrum permits the chair to tilt back from the front edge. This results in minimum vertical knee movement alleviates upward thigh pressure and improves access to lower desk areas. Its streamlined design and construction exceeds ANSI/BIFMA standards and offers permanently lubricated reinforced nylon bearings. This mechanism is offered with either mechanical or pneumatic height adjustment.

Adjustments: A. Tilt tension control knob
B. Pneumatic height adjustment lever
C. Manual height adjustment
D. Tilt lock push/pull rod

Typical Knee
Tilt Control

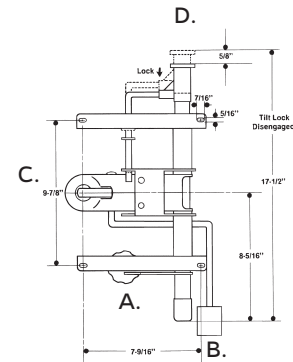

BASES

Bases E and L are constructed with solid steel understructures and solid hardwood base caps. Base P is cast fiberglass reinforced nylon.



E - \$225



L - \$200



P - \$65

PRODUCT SPECIFICATIONS

FINISHES

HC has eight key steps in the finishing process. These steps and the use of a catalyzed lacquer provide all products with a high quality long lasting finish. The steps are as follows:

1. Primary Machine Sand 100-120 Grit
2. Secondary Hand Sand 150-220 Grit
3. Apply Stain
4. Apply Sealer
5. Sand 280 Grit
6. Apply First Coats of Catalyzed Lacquer
7. Sand 320 Grit
8. Apply Second Coats of Catalyzed Lacquer

HC applies the finishes listed below to exposed beech/maple hardwood. If a different species of wood is required please contact the factory for price and availability.

Standard Finishes

Hickory Contract offers 10 standard wood grain finishes and 10 laminate choices. You may view these selections on line or inquire with customer service for samples.

Mahogany	Cherry
Walnut	Light Cherry
Black	Natural Maple
P. Mahogany	Pecan*
Oak	Kona

Light Finishes

HC offers several light finishes and custom matches many. These finishes do not hide or mask the natural characteristics of the wood. Both dealer and customer should understand that the natural characteristics of the wood will be a characteristic of the product. Natural characteristics of the product include the natural discoloration of the wood substance and color variations in glued up stock. These natural characteristics are not considered defects by HC and therefore will not warrant replacement or repair.

Custom Finishes

Hickory Contract will match other manufacturers finishes. Please submit a sample with your purchase order. Hickory Contract will have sole discretion concerning the correctness of the match unless an approval samples is requested and approved. The charges for custom finishes are as follows:

\$250 LIST per order
\$125 LIST per approval

The beauty of the wood is the result of natural variations in color and grain. Since no two trees are exactly alike, all woods may vary in color, grain configuration and stain acceptance. Therefore, even though veneers and solids are carefully selected, an exact matching of color and grain cannot be guaranteed.

WELT GUARDS

A 10" long clear Polyvinyl welt guard is standard on all Traditional Executive Swivel Chairs. Please note on order if guard should be deleted.

COMBINATIONS/CONTRASTING WELTS

For contrasting welts or contrasting fabrics please add \$25.00 list/chair \$35.00 list/loveseat and \$45.00 list/sofa.

FIRE RETARDANT CODES

Most products are manufactured to meet California Technical Bulletin 117. HC can manufacture its product with components which should allow the product to meet California Technical Bulletin 133 Requirements. Please contact the factory for pricing. Should certification be required customer is responsible for cost of sample and testing fees.

CUSHION TIE STRAPS

For tie straps which prevent lounge cushions from being easily removed add \$40.00 list/chair \$120.00 list/loveseat and \$160 list/sofa.

LUMBAR BACKS

Additional lumbar support is available on many products. Please consult product pricing pages or the factory for availability and charge.

LEATHER

No two pieces of leather furniture are exactly the same. Color variations and distinctive natural markings make each piece of leather furniture unique.

Color variation is a natural occurrence with pure aniline dyed top grain leathers. In the dying process no pigments are used. Each hide absorbs "color" in varying amounts based on individual cell structure so even areas within the same hide may vary in color.

Color variation is an inherent quality of the antiquing process in hand antiqued leather.

Healed scars scratches insect bites and wrinkles provide yet another Dimensions/ of individuality to leather. All of the above are natural characteristics of leather and are not considered defects by HC.

NAILHEADS

The standard nailhead offered on all Hickory Contract furniture is a 1/2" French Natural (brass). We offer at no additional charge 5 other choices. You may view these selections on our website or contact customer service for additional information.

CUSTOMER'S OWN MATERIAL

CUSTOMER'S OWN MATERIAL (C.O.M)

All items are available with material furnished by the purchaser and should be priced in grade A. Yardage requirements listed in our price list are based on 54" wide plain material. Generally additional yardage is required if striped or patterned material is used if pattern requires matching or if width of materials is less than 54" wide. HC strongly recommends a sample of the C.O.M. material be submitted for review and approval prior to ordering. We can take no responsibility for tailoring wearability or application of C.O.M. covers.

TEXTILE GRADING

COM should be priced in Grade "A". COL should be priced in Grade "C". COM COL and all leather grades are noted in header above each products zoned pricing.

C.O.M CHART

Though every effort has been made to estimate excess yardage required for stripes and matches HC takes no responsibility where additional material must be ordered. HC will supply yardage requirements for large quantities revisions and special match upon request.

Refer to the following guideline when figuring C.O.M. requirements:

		Railbanded					
Fabric Width	Plain Fabric	Repeat					
		1-5"	6-9"	10-13"	14-20"	21-27"	28-34"
54"	0%	+10%	+15%	+20%	+25%	+30%	+35%
50"	+15%	+15%	+20%	+25%	+30%	+35%	+40%
48"	+20%	+20%	+25%	+30%	+35%	+40%	+45%

"Railroad" or "Top to Selvage"

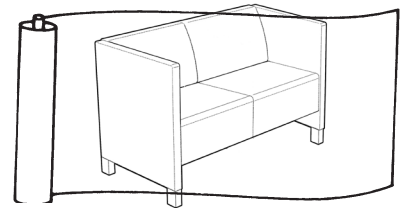

		Up The Roll					
Fabric Width	Plain Fabric	Repeat					
		1-5"	6-9"	10-13"	14-20"	21-27"	28-34"
54"	0%	+15%	+18%	+25%	+30%	+35%	+40%
50"	+15%	+20%	+25%	+30%	+35%	+40%	+45%
48"	+20%	+25%	+30%	+35%	+40%	+45%	+50%

Up the Roll

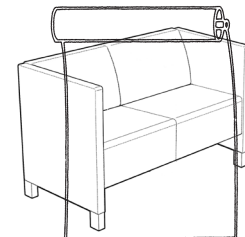

ALL C.O.M.'s AND C.O.L.'s

In absence of specific written instructions accompanying the order fabrics will be cut seamed and applied at HC's discretion and at customer's risk. While HC inspects fabrics for mill imperfections some are difficult to recognize. HC cannot be responsible for defects color inaccuracies dye lot variations/flaws and suggests that our customer inspect fabrics before furnishing them to the factory. HC will make a concentrated effort to control C.O.M. and C.O.L. materials. It is not HC's responsibility to police the receipt of C.O.M. and C.O.L. material in order to meet delivery deadlines and we assume that customers are aware of any undue delay in the delivery of their C.O.M. and C.O.L. materials. All C.O.M. and C.O.L. must be clearly tagged with customer name/ Purchase Order Number/Product Number.

SHIP C.O.M. PREPAID

HC
7514 West NC #10 Hwy.
Vale NC 28168 ATTN: COM/COL Dept.

HC TEXTILE PROGRAMS

HC's textile program offers five types of leathers and over 10,000 different choices of fabrics and vinyls. For grading information, please visit our website at www.HickoryContract.com and visit the textile page.

MAYER

The entire Mayer line is available through HC. For free memo samples call Mayer Fabrics at 800-428-4415. www.mayerfabrics.com



ULTRA FABRICS

The entire Ultra Fabrics line is available through HC. For fabric samples call 877.309.6648. www.ultrafabricsllc.com



MOMENTUM

The entire Momentum line is available through HC. For free memo samples call Momentum at 800-366-6839. www.memosamples.com



DOUGLAS

The entire Douglas line is available through HC. For fabric samples please call 800.950.3684. www.douglassfabrics.com



CF STINSON

The entire CF Stinson line is available through HC. For free memo samples, contact CF Stinson at 800-841-6279



CULP FABRICS

The entire Culp Fabrics line is available through HC. For fabric samples call 336-888-6274. culpcontract.com



HC LEATHER PROGRAMS

RIO

RIO is the go to leather when the demand for durability and value are the top priority. The color options are a minimalist approach that is current and relevant. RIO is dyed for color then pigmented to provide color consistency and a protective finish which is perfect for high traffic areas.

BELLA

Casual elegance and a large color palette make BELLA an easy choice when selecting leather. This color consistent and durable upholstery leather provides a soft drape and hand that tailors exceptionally well. Produced on select European hides this collection provides a premium quality at an affordable grade. BELLA is specified to meet the requirements for contract and hospitality uses.

SANTA FE

SANTA FE is a smart choice for the customer looking for a wax/crackle leather that won't easily scratch. SANTA FE provides that desirable vintage look but offers a protective finish making it suitable for high traffic area. Each hide is aniline dyed and receives a special protective wax top coat for durability and softness. Due to the inherent nature of this raw material, scratches, bruises, scars and insect bites may be noticeable but only add to the richness of this vintage leather.

AVALON

Avalon is a top grain, lightly corrected semi-aniline leather Powered by Crypton, which is bleach cleanable, antimicrobial, antibacterial and stain resistant. Fully aniline dyed and highlighted by a pebble grain, Avalon is available in 25 design driven colors. Durable and ideally suited for healthcare and hospitality applications, Avalon is environmentally friendly and solvent free.

HEIRLOOM

All of the beauty that makes an antique leather desirable is offered in HEIRLOOM at a value price. The subtle hand-wipe effect adds dramatic color depth and produces a two-tone look that is ageless and inviting.

VINTAGE

VINTAGE is a domestic top grain, aniline dyed leather that features Old World craftsmanship of a hand rubbed antiqued finish and is frequently referred to as a glazed leather because of its high sheen. The authentic hand antiquing gives this fine leather its distinctive and unique look. Environmentally friendly, Vintage is available in 9 relevant colors and is an excellent hand antiqued leather choice for the discriminating contract customer.



HC ENVIRONMENTAL POLICY

HC's environmental effort begins by designing and building durable products backed by a ten year warranty. This is a goal aimed at preserving natural resources. It means our products limit the "dispose and repurchase" cycle that constantly burdens our environment with used and wasted furniture.

The safety of employees the community and environmental factors are also considered in the design of products and all production processes. HC's two manufacturing facilities function in full compliance with all applicable EPA and OSHA regulations.

HC identifies the environmental aspects of its business activities manufacturing operations products and services and then strives to prevent or reduce environmental impacts within our control including application of the best available technology and management practices.

HC's Environmental Policy and Goals include:

- Hardwoods from suppliers who practice conservation and reforestation programs not utilizing wood species from endangered rain forests
- Parts manufactured by approved suppliers who apply modern technologies that are not harmful to the environment
- Beech frame construction which is free of formaldehyde often used by others utilizing plywood in their construction
- Technology that maximizes the best and highest quality yield
- Chemicals and adhesives that are formulated to meet or exceed environmental standards
- Alternate packaging methods such as blanket wrapping to reduce use of cardboard packaging
- Transportation management system that contracts with trucking lines who efficiently time shipments to ensure as full as possible shipments to conserve energy
- Maximize use of recyclable packaging materials
- Many recycled materials in the operation of the administrative promotional and financial activities that occur in the operation of HC's daily business

HC also employs processes and materials that prevent reduce or minimize pollution. This includes control mechanisms material substitution efficient use of resources and recycling.

HC will continually explore creative responsible ways to do business and manufacture products so as to better preserve our natural resources and protect the environment for future generations.