



Urban Pricebook

2018



URBAN COLLECTION

Armless Chairs



Seat Construction: Webbing

Wood Species: Solid Beech Hardwood / Engineered Hardwood

SIN # 711-16

Arm Options



Open Arm

Inset Upholstery Panel (Partial)

Fully Upholstered Arm

Base Options

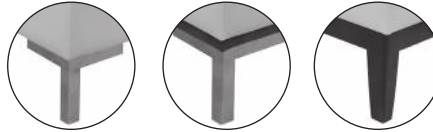

(-M) Metal

(-MW) Metal with Wood Trim

(-W) Solid Wood

Swivel Tablet Options



Round Table (Arm Mounted) \$500 List

Rectangle Table (Base Mounted) \$500 List

Electrical Options

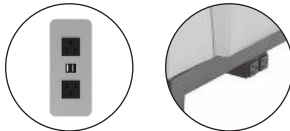

COV2U +\$490 List

Base Mounted Outlet \$250 List

Ganging, Casters and Handles



Ganger Arm for Modular Attachments \$110 List

(-C) Locking Casters for Mobility \$100 List pair

(-H) Handles for Pushing & Pulling \$75 List

Table Top Options

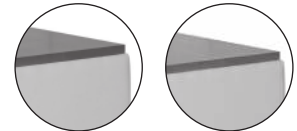

Laminate

Hardwood

Color Options (COV2U only):
White/Black/Silver

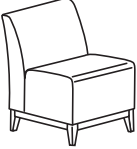

5310-W Armless Chair	Dimensions/ Yardage	Zone Grade	COM A	B	COL C	D	E	F	G	H	I	J	K	L
 Solid Wood Base	Outside 24W 27D 32H Inside S/H 19 3 yd. 51 sq. ft.	ZONE 1	\$845	\$913	\$981	\$1048	\$1116	\$1185	\$1253	\$1321	\$1389	\$1456	\$1524	\$1592
		ZONE 2	\$867	\$937	\$1007	\$1076	\$1146	\$1216	\$1286	\$1356	\$1425	\$1495	\$1565	\$1635
		ZONE 3	\$890	\$962	\$1034	\$1106	\$1177	\$1249	\$1320	\$1392	\$1464	\$1535	\$1607	\$1678
		ZONE 4	\$915	\$989	\$1062	\$1136	\$1209	\$1284	\$1357	\$1431	\$1504	\$1577	\$1651	\$1725
		ZONE 5	\$941	\$1018	\$1093	\$1168	\$1244	\$1320	\$1396	\$1471	\$1548	\$1623	\$1698	\$1774

Approximate Shipping weight: 45 lbs

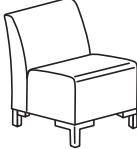
5310-M Armless Chair	Dimensions/ Yardage	Zone Grade	COM A	B	COL C	D	E	F	G	H	I	J	K	L
 Metal Base	Outside 24W 27D 32H Inside S/H 19 3 yd. 51 sq. ft.	ZONE 1	\$779	\$856	\$934	\$1011	\$1089	\$1166	\$1242	\$1320	\$1397	\$1474	\$1552	\$1628
		ZONE 2	\$803	\$883	\$962	\$1042	\$1121	\$1201	\$1280	\$1360	\$1439	\$1519	\$1598	\$1678
		ZONE 3	\$828	\$909	\$992	\$1074	\$1155	\$1238	\$1320	\$1401	\$1483	\$1566	\$1647	\$1729
		ZONE 4	\$854	\$939	\$1023	\$1108	\$1193	\$1277	\$1362	\$1446	\$1531	\$1615	\$1700	\$1785
		ZONE 5	\$882	\$970	\$1057	\$1145	\$1232	\$1320	\$1407	\$1494	\$1582	\$1668	\$1756	\$1843

Approximate Shipping weight: 45 lbs

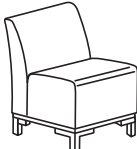
5310-MW Armless Chair	Dimensions/ Yardage	Zone Grade	COM A	B	COL C	D	E	F	G	H	I	J	K	L
 Metal with Wood Trim Base	Outside 24W 27D 32H Inside S/H 19 3 yd. 51 sq. ft.	ZONE 1	\$873	\$953	\$1031	\$1110	\$1188	\$1268	\$1346	\$1425	\$1503	\$1583	\$1661	\$1739
		ZONE 2	\$900	\$982	\$1063	\$1144	\$1225	\$1306	\$1388	\$1468	\$1550	\$1630	\$1712	\$1792
		ZONE 3	\$929	\$1012	\$1096	\$1180	\$1264	\$1347	\$1431	\$1515	\$1598	\$1682	\$1766	\$1850
		ZONE 4	\$959	\$1045	\$1132	\$1218	\$1305	\$1392	\$1478	\$1565	\$1650	\$1737	\$1823	\$1910
		ZONE 5	\$991	\$1081	\$1170	\$1259	\$1348	\$1438	\$1527	\$1617	\$1707	\$1796	\$1885	\$1974

Approximate Shipping weight: 45 lbs



URBAN COLLECTION - Open Arm Chairs

Seat Construction: Webbing

Wood Species: Solid Beech Hardwood / Engineered Hardwood

5311-W Open Arm Chair	Dimensions/ Yardage	Zone Grade	COM A	B	COL C	D	E	F	G	H	I	J	K	L
 Solid Wood Base	Outside 28W 27D 32H Inside A/H 25 S/H 19 3 yd. 51 sq. ft.	ZONE 1	\$1161	\$1226	\$1292	\$1358	\$1424	\$1489	\$1555	\$1621	\$1686	\$1752	\$1818	\$1884
		ZONE 2	\$1190	\$1257	\$1325	\$1393	\$1460	\$1527	\$1594	\$1662	\$1729	\$1797	\$1863	\$1931
		ZONE 3	\$1221	\$1290	\$1360	\$1429	\$1498	\$1567	\$1636	\$1706	\$1774	\$1843	\$1912	\$1982
		ZONE 4	\$1254	\$1325	\$1396	\$1467	\$1538	\$1609	\$1680	\$1751	\$1822	\$1893	\$1964	\$2035
		ZONE 5	\$1289	\$1361	\$1434	\$1507	\$1580	\$1654	\$1726	\$1799	\$1872	\$1945	\$2018	\$2090

Approximate Shipping weight: 50 lbs

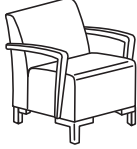
5311-M Open Arm Chair	Dimensions/ Yardage	Zone Grade	COM A	B	COL C	D	E	F	G	H	I	J	K	L
 Metal Base	Outside 24W 27D 32H Inside A/H 25 S/H 19 3 yd. 51 sq. ft.	ZONE 1	\$1056	\$1121	\$1187	\$1253	\$1319	\$1384	\$1450	\$1516	\$1582	\$1647	\$1713	\$1779
		ZONE 2	\$1082	\$1150	\$1217	\$1285	\$1352	\$1419	\$1487	\$1554	\$1622	\$1689	\$1756	\$1823
		ZONE 3	\$1111	\$1180	\$1249	\$1318	\$1388	\$1456	\$1525	\$1594	\$1664	\$1733	\$1802	\$1871
		ZONE 4	\$1141	\$1212	\$1283	\$1354	\$1425	\$1496	\$1567	\$1638	\$1709	\$1780	\$1851	\$1922
		ZONE 5	\$1172	\$1244	\$1318	\$1391	\$1464	\$1537	\$1609	\$1682	\$1755	\$1829	\$1902	\$1974

Approximate Shipping weight: 50 lbs

5311-MW Open Arm Chair	Dimensions/ Yardage	Zone Grade	COM A	B	COL C	D	E	F	G	H	I	J	K	L
 Metal with Wood Trim Base	Outside 24W 27D 32H Inside A/H 25 S/H 19 3 yd. 51 sq. ft.	ZONE 1	\$1198	\$1264	\$1329	\$1395	\$1461	\$1526	\$1592	\$1658	\$1724	\$1789	\$1855	\$1921
		ZONE 2	\$1229	\$1295	\$1363	\$1431	\$1498	\$1566	\$1632	\$1700	\$1767	\$1835	\$1902	\$1969
		ZONE 3	\$1260	\$1329	\$1399	\$1468	\$1537	\$1606	\$1675	\$1745	\$1814	\$1883	\$1951	\$2021
		ZONE 4	\$1294	\$1365	\$1436	\$1507	\$1578	\$1649	\$1720	\$1791	\$1862	\$1933	\$2004	\$2075
		ZONE 5	\$1330	\$1402	\$1476	\$1549	\$1622	\$1695	\$1767	\$1840	\$1913	\$1986	\$2060	\$2132

Approximate Shipping weight: 50 lbs

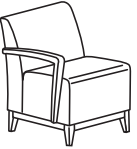
5311W-LSS/RSS Open Arm Chair	Dimensions/ Yardage	Zone Grade	COM A	B	COL C	D	E	F	G	H	I	J	K	L
 Solid Wood Base	Outside 28W 27D 32H Inside A/H 25 S/H 19 3 yd. 51 sq. ft.	ZONE 1	\$1065	\$1131	\$1197	\$1262	\$1328	\$1394	\$1460	\$1525	\$1591	\$1657	\$1723	\$1788
		ZONE 2	\$1095	\$1162	\$1230	\$1297	\$1364	\$1432	\$1499	\$1567	\$1633	\$1701	\$1768	\$1836
		ZONE 3	\$1126	\$1195	\$1265	\$1333	\$1402	\$1471	\$1540	\$1610	\$1679	\$1748	\$1817	\$1887
		ZONE 4	\$1159	\$1230	\$1301	\$1372	\$1443	\$1514	\$1585	\$1656	\$1727	\$1798	\$1869	\$1940
		ZONE 5	\$1194	\$1266	\$1339	\$1412	\$1485	\$1558	\$1630	\$1703	\$1777	\$1850	\$1923	\$1995

Approximate Shipping weight: 50 lbs

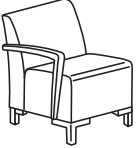
5311M-RSS/LSS Open Arm Chair	Dimensions/ Yardage	Zone Grade	COM A	B	COL C	D	E	F	G	H	I	J	K	L
 Metal Base	Outside 32H 28W 27D Inside A/H 25 S/H 19 3 yd. 51 sq. ft.	ZONE 1	\$960	\$1026	\$1092	\$1158	\$1223	\$1289	\$1355	\$1420	\$1486	\$1552	\$1618	\$1683
		ZONE 2	\$987	\$1055	\$1121	\$1189	\$1256	\$1324	\$1392	\$1459	\$1526	\$1593	\$1661	\$1728
		ZONE 3	\$1015	\$1084	\$1153	\$1222	\$1292	\$1361	\$1430	\$1499	\$1569	\$1638	\$1707	\$1776
		ZONE 4	\$1045	\$1116	\$1187	\$1258	\$1329	\$1400	\$1471	\$1542	\$1613	\$1684	\$1755	\$1826
		ZONE 5	\$1077	\$1149	\$1222	\$1295	\$1368	\$1442	\$1514	\$1587	\$1660	\$1733	\$1806	\$1878

Approximate Shipping weight: 50 lbs

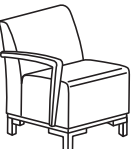
5311MW-RSS/LSS Open Arm Chair	Dimensions/ Yardage	Zone Grade	COM A	B	COL C	D	E	F	G	H	I	J	K	L
 Metal with Wood Trim Base	Outside 32H 28W 27D Inside A/H 25 S/H 19 3 yd. 51 sq. ft.	ZONE 1	\$1102	\$1168	\$1234	\$1300	\$1365	\$1431	\$1497	\$1562	\$1628	\$1694	\$1760	\$1825
		ZONE 2	\$1133	\$1200	\$1268	\$1336	\$1402	\$1470	\$1537	\$1605	\$1672	\$1739	\$1806	\$1874
		ZONE 3	\$1165	\$1234	\$1304	\$1373	\$1442	\$1511	\$1579	\$1649	\$1718	\$1787	\$1856	\$1926
		ZONE 4	\$1199	\$1270	\$1341	\$1412	\$1483	\$1554	\$1625	\$1696	\$1767	\$1838	\$1909	\$1980
		ZONE 5	\$1235	\$1307	\$1380	\$1453	\$1526	\$1600	\$1672	\$1745	\$1818	\$1891	\$1964	\$2036

Approximate Shipping weight: 50 lbs



URBAN COLLECTION - Closed Arm Chairs

Seat Construction: Webbing

Wood Species: Solid Beech Hardwood / Engineered Hardwood

SIN # 711-16

5312W Closed Arm Chair	Dimensions/ Yardage	Zone Grade	COM A	B	COL C	D	E	F	G	H	I	J	K	L
 Solid Wood Base	Outside 28W 27D 32H Inside A/H 25 S/H 19 4 yd. 60 sq. ft.	ZONE 1	\$1410	\$1491	\$1574	\$1656	\$1737	\$1820	\$1902	\$1984	\$2066	\$2149	\$2230	\$2313
		ZONE 2	\$1445	\$1530	\$1613	\$1698	\$1782	\$1867	\$1950	\$2034	\$2119	\$2203	\$2287	\$2371
		ZONE 3	\$1483	\$1569	\$1656	\$1742	\$1829	\$1915	\$2001	\$2088	\$2174	\$2261	\$2347	\$2434
		ZONE 4	\$1522	\$1611	\$1700	\$1789	\$1877	\$1966	\$2055	\$2143	\$2232	\$2321	\$2409	\$2498
		ZONE 5	\$1565	\$1656	\$1747	\$1838	\$1929	\$2020	\$2112	\$2203	\$2294	\$2385	\$2476	\$2567

Approximate Shipping weight: 55 lbs

5312-M Closed Arm Chair	Dimensions/ Yardage	Zone Grade	COM A	B	COL C	D	E	F	G	H	I	J	K	L
 Metal Base	Outside 24W 27D 32H Inside A/H 25 S/H 19 4 yd. 60 sq. ft.	ZONE 1	\$1309	\$1391	\$1472	\$1555	\$1637	\$1719	\$1801	\$1884	\$1965	\$2048	\$2130	\$2212
		ZONE 2	\$1342	\$1426	\$1511	\$1594	\$1679	\$1763	\$1848	\$1931	\$2015	\$2100	\$2184	\$2268
		ZONE 3	\$1377	\$1463	\$1550	\$1636	\$1723	\$1809	\$1895	\$1982	\$2068	\$2155	\$2241	\$2328
		ZONE 4	\$1414	\$1502	\$1591	\$1680	\$1769	\$1857	\$1946	\$2035	\$2123	\$2212	\$2301	\$2389
		ZONE 5	\$1452	\$1543	\$1635	\$1726	\$1817	\$1908	\$1999	\$2090	\$2181	\$2273	\$2365	\$2456

Approximate Shipping weight: 55 lbs

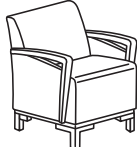
5312-MW Closed Arm Chair	Dimensions/ Yardage	Zone Grade	COM A	B	COL C	D	E	F	G	H	I	J	K	L
 Metal with Wood Trim Base	Outside 24W 27D 32H Inside A/H 25 S/H 19 4 yd. 60 sq. ft.	ZONE 1	\$1451	\$1533	\$1615	\$1697	\$1780	\$1861	\$1944	\$2026	\$2108	\$2190	\$2273	\$2354
		ZONE 2	\$1488	\$1572	\$1657	\$1741	\$1824	\$1909	\$1993	\$2078	\$2161	\$2246	\$2330	\$2415
		ZONE 3	\$1526	\$1613	\$1699	\$1786	\$1872	\$1959	\$2045	\$2132	\$2218	\$2304	\$2390	\$2477
		ZONE 4	\$1568	\$1657	\$1745	\$1834	\$1923	\$2011	\$2100	\$2189	\$2277	\$2366	\$2455	\$2544
		ZONE 5	\$1610	\$1702	\$1794	\$1885	\$1976	\$2067	\$2158	\$2249	\$2340	\$2432	\$2523	\$2614

Approximate Shipping weight: 55 lbs

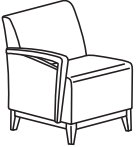
5312W-LSS/RSS Closed Arm Chair	Dimensions/ Yardage	Zone Grade	COM A	B	COL C	D	E	F	G	H	I	J	K	L
 Solid Wood Base	Outside 26W 27D 32H Inside A/H 25 S/H 19 3.5 yd. 60 sq. ft.	ZONE 1	\$1269	\$1342	\$1417	\$1490	\$1564	\$1638	\$1711	\$1786	\$1859	\$1934	\$2007	\$2082
		ZONE 2	\$1300	\$1377	\$1452	\$1528	\$1604	\$1680	\$1755	\$1831	\$1907	\$1982	\$2059	\$2134
		ZONE 3	\$1335	\$1412	\$1490	\$1567	\$1646	\$1724	\$1801	\$1879	\$1957	\$2035	\$2112	\$2190
		ZONE 4	\$1370	\$1450	\$1530	\$1610	\$1690	\$1770	\$1850	\$1929	\$2009	\$2089	\$2168	\$2249
		ZONE 5	\$1408	\$1490	\$1572	\$1654	\$1736	\$1818	\$1900	\$1982	\$2064	\$2147	\$2229	\$2311

Approximate Shipping weight: 55 lbs

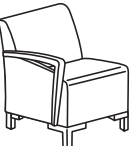
5312M-RSS/LSS Closed Arm Chair	Dimensions/ Yardage	Zone Grade	COM A	B	COL C	D	E	F	G	H	I	J	K	L
 Metal Base	Outside 26W 27D 32H Inside A/H 25 S/H 19 3.5 yd. 60 sq. ft.	ZONE 1	\$1178	\$1252	\$1325	\$1400	\$1473	\$1547	\$1621	\$1695	\$1769	\$1843	\$1917	\$1991
		ZONE 2	\$1208	\$1283	\$1359	\$1435	\$1511	\$1587	\$1663	\$1738	\$1814	\$1890	\$1965	\$2042
		ZONE 3	\$1239	\$1317	\$1395	\$1472	\$1550	\$1628	\$1706	\$1784	\$1861	\$1939	\$2017	\$2095
		ZONE 4	\$1273	\$1352	\$1432	\$1512	\$1592	\$1671	\$1752	\$1832	\$1911	\$1991	\$2071	\$2150
		ZONE 5	\$1307	\$1389	\$1471	\$1553	\$1635	\$1717	\$1799	\$1881	\$1963	\$2045	\$2128	\$2210

Approximate Shipping weight: 55 lbs

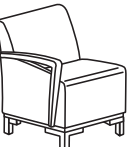
5312MW-RSS/LSS Closed Arm Chair	Dimensions/ Yardage	Zone Grade	COM A	B	COL C	D	E	F	G	H	I	J	K	L
 Metal with Wood Trim Base	Outside 24W 27D 32H Inside A/H 25 S/H 19 4 yd. 60 sq. ft.	ZONE 1	\$1306	\$1379	\$1454	\$1527	\$1602	\$1675	\$1750	\$1823	\$1898	\$1971	\$2045	\$2119
		ZONE 2	\$1339	\$1415	\$1491	\$1566	\$1642	\$1718	\$1794	\$1870	\$1945	\$2022	\$2097	\$2173
		ZONE 3	\$1374	\$1452	\$1529	\$1607	\$1685	\$1763	\$1840	\$1918	\$1996	\$2074	\$2151	\$2229
		ZONE 4	\$1411	\$1491	\$1570	\$1650	\$1731	\$1810	\$1890	\$1970	\$2049	\$2129	\$2209	\$2290
		ZONE 5	\$1449	\$1532	\$1614	\$1696	\$1778	\$1860	\$1942	\$2024	\$2106	\$2188	\$2271	\$2353

Approximate Shipping weight: 55 lbs



URBAN COLLECTION - Fully Uph. Arm Chairs

Seat Construction: Webbing

Wood Species: Solid Beech Hardwood / Engineered Hardwood

SIN # 711-16

5313W Fully Uph. Arm Chair	Dimensions/ Yardage	Zone Grade	COM A	B	COL C	D	E	F	G	H	I	J	K	L
 Solid Wood Base	Outside 30W 27D 32H Inside A/H 25 S/H 19 4 yd. 60 sq. ft.	ZONE 1	\$1026	\$1116	\$1207	\$1297	\$1389	\$1479	\$1570	\$1660	\$1751	\$1841	\$1932	\$2022
		ZONE 2	\$1053	\$1146	\$1239	\$1332	\$1425	\$1518	\$1611	\$1703	\$1797	\$1890	\$1983	\$2075
		ZONE 3	\$1081	\$1177	\$1272	\$1368	\$1464	\$1559	\$1655	\$1750	\$1845	\$1941	\$2036	\$2132
		ZONE 4	\$1112	\$1209	\$1308	\$1406	\$1504	\$1603	\$1700	\$1799	\$1896	\$1995	\$2094	\$2191
		ZONE 5	\$1144	\$1244	\$1345	\$1446	\$1548	\$1648	\$1749	\$1850	\$1950	\$2052	\$2153	\$2254

Approximate Shipping weight: 55 lbs

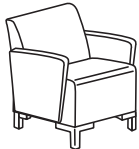
5313-M Fully Uph. Arm Chair	Dimensions/ Yardage	Zone Grade	COM A	B	COL C	D	E	F	G	H	I	J	K	L
 Metal Base	Outside 24W 27D 32H Inside A/H 25 S/H 19 4 yd. 60 sq. ft.	ZONE 1	\$915	\$1010	\$1106	\$1201	\$1296	\$1392	\$1487	\$1583	\$1678	\$1773	\$1870	\$1965
		ZONE 2	\$940	\$1038	\$1136	\$1234	\$1332	\$1431	\$1529	\$1627	\$1725	\$1823	\$1922	\$2019
		ZONE 3	\$967	\$1067	\$1168	\$1270	\$1371	\$1471	\$1572	\$1674	\$1774	\$1875	\$1976	\$2078
		ZONE 4	\$995	\$1099	\$1203	\$1307	\$1411	\$1515	\$1619	\$1723	\$1826	\$1930	\$2034	\$2138
		ZONE 5	\$1025	\$1132	\$1239	\$1346	\$1453	\$1560	\$1667	\$1774	\$1882	\$1989	\$2096	\$2203

Approximate Shipping weight: 55 lbs

5313-MW Fully Uph. Arm Chair	Dimensions/ Yardage	Zone Grade	COM A	B	COL C	D	E	F	G	H	I	J	K	L
 Metal with Wood Trim Base	Outside 24W 27D 32H Inside A/H 25 S/H 19 4 yd. 60 sq. ft.	ZONE 1	\$1032	\$1132	\$1233	\$1332	\$1432	\$1533	\$1632	\$1732	\$1833	\$1932	\$2032	\$2133
		ZONE 2	\$1062	\$1166	\$1269	\$1372	\$1474	\$1577	\$1680	\$1783	\$1886	\$1989	\$2091	\$2194
		ZONE 3	\$1095	\$1201	\$1307	\$1413	\$1519	\$1625	\$1731	\$1837	\$1943	\$2049	\$2155	\$2261
		ZONE 4	\$1128	\$1238	\$1347	\$1456	\$1566	\$1675	\$1784	\$1893	\$2002	\$2112	\$2221	\$2330
		ZONE 5	\$1164	\$1277	\$1390	\$1503	\$1615	\$1728	\$1841	\$1954	\$2066	\$2179	\$2292	\$2405

Approximate Shipping weight: 55 lbs

5313W-LSS/RSS Fully Uph. Arm Chair	Dimensions/ Yardage	Zone Grade	COM A	B	COL C	D	E	F	G	H	I	J	K	L
 Solid Wood Base	Outside 27W 27D 32H Inside A/H 25 S/H 19 3.5 yd. 60 sq. ft.	ZONE 1	\$1026	\$1116	\$1207	\$1297	\$1389	\$1479	\$1570	\$1660	\$1751	\$1841	\$1932	\$2022
		ZONE 2	\$1053	\$1146	\$1239	\$1332	\$1425	\$1518	\$1611	\$1703	\$1797	\$1890	\$1983	\$2075
		ZONE 3	\$1081	\$1177	\$1272	\$1368	\$1464	\$1559	\$1655	\$1750	\$1845	\$1941	\$2036	\$2132
		ZONE 4	\$1112	\$1209	\$1308	\$1406	\$1504	\$1603	\$1700	\$1799	\$1896	\$1995	\$2094	\$2191
		ZONE 5	\$1144	\$1244	\$1345	\$1446	\$1548	\$1648	\$1749	\$1850	\$1950	\$2052	\$2153	\$2254

Approximate Shipping weight: 55 lbs

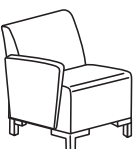
5313M-RSS/LSS Fully Uph. Arm Chair	Dimensions/ Yardage	Zone Grade	COM A	B	COL C	D	E	F	G	H	I	J	K	L
 Metal Base	Outside 27W 27D 32H Inside A/H 25 S/H 19 3.5 yd. 60 sq. ft.	ZONE 1	\$869	\$960	\$1050	\$1141	\$1232	\$1322	\$1413	\$1503	\$1594	\$1685	\$1776	\$1867
		ZONE 2	\$893	\$986	\$1080	\$1172	\$1266	\$1359	\$1452	\$1546	\$1638	\$1732	\$1826	\$1918
		ZONE 3	\$918	\$1014	\$1110	\$1206	\$1302	\$1398	\$1493	\$1590	\$1686	\$1781	\$1877	\$1974
		ZONE 4	\$946	\$1044	\$1143	\$1242	\$1340	\$1439	\$1538	\$1636	\$1735	\$1834	\$1932	\$2031
		ZONE 5	\$974	\$1075	\$1177	\$1279	\$1381	\$1482	\$1584	\$1686	\$1787	\$1889	\$1991	\$2093

Approximate Shipping weight: 55 lbs

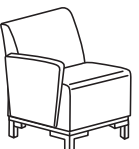
5313MW-RSS/LSS Fully Uph. Arm Chair	Dimensions/ Yardage	Zone Grade	COM A	B	COL C	D	E	F	G	H	I	J	K	L
 Metal with Wood Trim Base	Outside 27W 27D 32H Inside A/H 25 S/H 19 3.5 yd. 60 sq. ft.	ZONE 1	\$1026	\$1116	\$1207	\$1297	\$1389	\$1479	\$1570	\$1660	\$1751	\$1841	\$1932	\$2022
		ZONE 2	\$1053	\$1146	\$1239	\$1332	\$1425	\$1518	\$1611	\$1703	\$1797	\$1890	\$1983	\$2075
		ZONE 3	\$1081	\$1177	\$1272	\$1368	\$1464	\$1559	\$1655	\$1750	\$1845	\$1941	\$2036	\$2132
		ZONE 4	\$1112	\$1209	\$1308	\$1406	\$1504	\$1603	\$1700	\$1799	\$1896	\$1995	\$2094	\$2191
		ZONE 5	\$1144	\$1244	\$1345	\$1446	\$1548	\$1648	\$1749	\$1850	\$1950	\$2052	\$2153	\$2254

Approximate Shipping weight: 55 lbs



URBAN COLLECTION

Armless Loveseats

Seat Construction: Webbing

Wood Species: Solid Beech Hardwood / Engineered Hardwood

SIN # 711-16

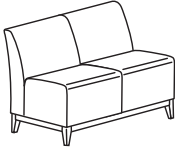
5320W Armless Love Seat	Dimensions/ Yardage	Zone Grade	COM A	B	COL C	D	E	F	G	H	I	J	K	L
	Outside 48W 27D 32H Inside S/H 19 4 yd. 68 sq. ft.	ZONE 1	\$1466	\$1566	\$1664	\$1764	\$1862	\$1961	\$2061	\$2159	\$2259	\$2357	\$2457	\$2556
		ZONE 2	\$1508	\$1610	\$1712	\$1815	\$1916	\$2018	\$2120	\$2222	\$2324	\$2425	\$2528	\$2630
		ZONE 3	\$1553	\$1658	\$1763	\$1868	\$1973	\$2078	\$2183	\$2287	\$2392	\$2497	\$2602	\$2707
		ZONE 4	\$1601	\$1709	\$1817	\$1925	\$2033	\$2141	\$2249	\$2357	\$2467	\$2575	\$2683	\$2791
		ZONE 5	\$1651	\$1763	\$1874	\$1986	\$2098	\$2209	\$2320	\$2433	\$2544	\$2655	\$2768	\$2879

Solid Wood Base

Approximate Shipping weight: 80 lbs

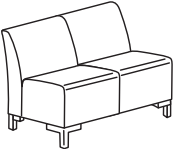
5320-M Armless Love Seat	Dimensions/ Yardage	Zone Grade	COM A	B	COL C	D	E	F	G	H	I	J	K	L
	Outside 48W 27D 32H Inside S/H 19 4 yd. 68 sq. ft.	ZONE 1	\$1377	\$1474	\$1573	\$1671	\$1769	\$1868	\$1965	\$2064	\$2161	\$2260	\$2359	\$2456
		ZONE 2	\$1416	\$1517	\$1618	\$1718	\$1820	\$1921	\$2021	\$2122	\$2224	\$2325	\$2425	\$2526
		ZONE 3	\$1458	\$1561	\$1665	\$1769	\$1873	\$1977	\$2081	\$2185	\$2289	\$2392	\$2496	\$2600
		ZONE 4	\$1502	\$1609	\$1716	\$1823	\$1930	\$2037	\$2144	\$2251	\$2359	\$2466	\$2573	\$2680
		ZONE 5	\$1549	\$1659	\$1769	\$1879	\$1991	\$2101	\$2211	\$2321	\$2432	\$2542	\$2653	\$2763

Metal Base

Non quilting detail deduct \$150 List. Approximate Shipping weight: 80 lbs

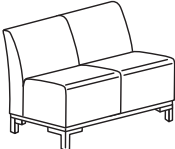
5320-MW Armless Love Seat	Dimensions/ Yardage	Zone Grade	COM A	B	COL C	D	E	F	G	H	I	J	K	L
	Outside 48W 27D 32H Inside S/H 19 4 yd. 68 sq. ft.	ZONE 1	\$1523	\$1622	\$1721	\$1820	\$1920	\$2018	\$2118	\$2216	\$2316	\$2415	\$2513	\$2613
		ZONE 2	\$1567	\$1670	\$1771	\$1873	\$1975	\$2077	\$2178	\$2280	\$2383	\$2485	\$2586	\$2688
		ZONE 3	\$1613	\$1718	\$1823	\$1928	\$2033	\$2138	\$2243	\$2348	\$2453	\$2558	\$2663	\$2768
		ZONE 4	\$1663	\$1771	\$1879	\$1988	\$2096	\$2204	\$2312	\$2420	\$2528	\$2636	\$2744	\$2852
		ZONE 5	\$1715	\$1827	\$1939	\$2050	\$2161	\$2274	\$2385	\$2496	\$2609	\$2720	\$2831	\$2943

Metal with
Wood Trim Base

Non quilting detail deduct \$150 List. Approximate Shipping weight: 80 lbs



URBAN COLLECTION

Open Arm Loveseats

Seat Construction: Webbing

Wood Species: Solid Beech Hardwood / Engineered Hardwood

SIN # 711-16

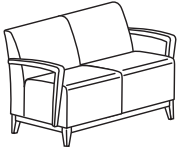
5321W Open Arm Love Seat	Dimensions/ Yardage	Zone Grade	COM A	B	COL C	D	E	F	G	H	I	J	K	L
	Outside 52W 27D 32H Inside S/H19 A/H25 4 yd. 68 sq. ft.	ZONE 1	\$1782	\$1882	\$1980	\$2080	\$2178	\$2277	\$2377	\$2475	\$2575	\$2673	\$2773	\$2872
		ZONE 2	\$1824	\$1926	\$2028	\$2131	\$2232	\$2334	\$2436	\$2538	\$2639	\$2741	\$2844	\$2946
		ZONE 3	\$1869	\$1974	\$2079	\$2184	\$2289	\$2393	\$2498	\$2603	\$2708	\$2813	\$2918	\$3023
		ZONE 4	\$1916	\$2025	\$2133	\$2241	\$2349	\$2457	\$2565	\$2673	\$2783	\$2891	\$2999	\$3107
		ZONE 5	\$1967	\$2079	\$2190	\$2302	\$2414	\$2525	\$2636	\$2749	\$2860	\$2971	\$3084	\$3195

Solid Wood Base

Approximate Shipping weight: 90 lbs

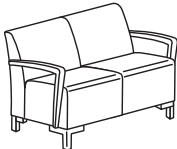
5321-M Open Arm Love Seat	Dimensions/ Yardage	Zone Grade	COM A	B	COL C	D	E	F	G	H	I	J	K	L
	Outside 52W 27D 32H Inside S/H19 A/H25 4 yd. 68 sq. ft.	ZONE 1	\$1693	\$1790	\$1889	\$1986	\$2085	\$2184	\$2281	\$2380	\$2477	\$2576	\$2674	\$2772
		ZONE 2	\$1732	\$1833	\$1933	\$2034	\$2136	\$2237	\$2337	\$2438	\$2540	\$2640	\$2741	\$2842
		ZONE 3	\$1773	\$1877	\$1981	\$2085	\$2189	\$2293	\$2397	\$2501	\$2604	\$2708	\$2812	\$2916
		ZONE 4	\$1818	\$1925	\$2032	\$2139	\$2246	\$2353	\$2460	\$2567	\$2674	\$2781	\$2889	\$2996
		ZONE 5	\$1865	\$1975	\$2085	\$2195	\$2307	\$2417	\$2527	\$2637	\$2748	\$2858	\$2969	\$3079

Metal Base

Non quilting detail deduct \$150 List. Approximate Shipping weight: 90 lbs

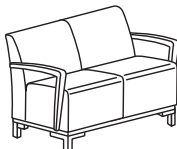
5321-MW Open Arm Love Seat	Dimensions/ Yardage	Zone Grade	COM A	B	COL C	D	E	F	G	H	I	J	K	L
	Outside 52W 27D 32H Inside S/H19 A/H25 4 yd. 68 sq. ft.	ZONE 1	\$1839	\$1938	\$2037	\$2136	\$2236	\$2334	\$2434	\$2532	\$2632	\$2731	\$2829	\$2929
		ZONE 2	\$1883	\$1985	\$2087	\$2189	\$2291	\$2392	\$2494	\$2596	\$2699	\$2801	\$2902	\$3004
		ZONE 3	\$1929	\$2034	\$2139	\$2244	\$2349	\$2454	\$2559	\$2664	\$2769	\$2874	\$2979	\$3084
		ZONE 4	\$1979	\$2087	\$2195	\$2303	\$2412	\$2520	\$2628	\$2736	\$2844	\$2952	\$3060	\$3168
		ZONE 5	\$2031	\$2143	\$2255	\$2366	\$2477	\$2590	\$2701	\$2812	\$2925	\$3036	\$3147	\$3258

Metal with
Wood Trim Base

Non quilting detail deduct \$150 List. Approximate Shipping weight: 90 lbs



URBAN COLLECTION

Closed Arm Loveseats

Seat Construction: Webbing

Wood Species: Solid Beech Hardwood / Engineered Hardwood

SIN # 711-16

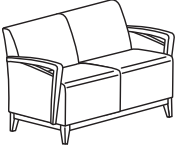
5322W Closed Arm Love Seat	Dimensions/ Yardage	Zone Grade	COM A	B	COL C	D	E	F	G	H	I	J	K	L
	Outside 52W 27D 32H Inside S/H19 A/H25 4 yd. 68 sq. ft.	ZONE 1	\$2031	\$2131	\$2229	\$2329	\$2427	\$2526	\$2626	\$2724	\$2824	\$2922	\$3022	\$3121
		ZONE 2	\$2073	\$2175	\$2277	\$2380	\$2481	\$2583	\$2685	\$2787	\$2889	\$2990	\$3093	\$3195
		ZONE 3	\$2118	\$2223	\$2328	\$2433	\$2538	\$2643	\$2748	\$2852	\$2957	\$3062	\$3167	\$3272
		ZONE 4	\$2166	\$2274	\$2382	\$2490	\$2598	\$2706	\$2814	\$2922	\$3032	\$3140	\$3248	\$3356
		ZONE 5	\$2216	\$2328	\$2439	\$2551	\$2663	\$2774	\$2885	\$2998	\$3109	\$3220	\$3333	\$3444

Solid Wood Base

Approximate Shipping weight: 95 lbs

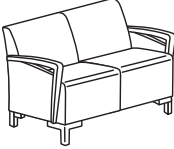
5322-M Closed Arm Love Seat	Dimensions/ Yardage	Zone Grade	COM A	B	COL C	D	E	F	G	H	I	J	K	L
	Outside 52W 27D 32H Inside S/H19 A/H25 4 yd. 68 sq. ft.	ZONE 1	\$1942	\$2039	\$2138	\$2236	\$2334	\$2433	\$2530	\$2629	\$2726	\$2825	\$2923	\$3021
		ZONE 2	\$1981	\$2082	\$2183	\$2283	\$2385	\$2486	\$2586	\$2687	\$2789	\$2890	\$2990	\$3091
		ZONE 3	\$2022	\$2126	\$2230	\$2334	\$2438	\$2542	\$2646	\$2750	\$2854	\$2957	\$3061	\$3165
		ZONE 4	\$2067	\$2174	\$2281	\$2388	\$2495	\$2602	\$2709	\$2816	\$2923	\$3031	\$3138	\$3245
		ZONE 5	\$2114	\$2224	\$2334	\$2444	\$2556	\$2666	\$2776	\$2886	\$2997	\$3107	\$3218	\$3328

Metal Base

Approximate Shipping weight: 95 lbs

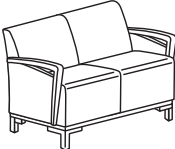
5322-MW Closed Arm Love Seat	Dimensions/ Yardage	Zone Grade	COM A	B	COL C	D	E	F	G	H	I	J	K	L
	Outside 52W 27D 32H Inside S/H19 A/H25 4 yd. 68 sq. ft.	ZONE 1	\$2088	\$2187	\$2286	\$2385	\$2485	\$2583	\$2683	\$2781	\$2881	\$2980	\$3078	\$3178
		ZONE 2	\$2132	\$2234	\$2336	\$2438	\$2540	\$2642	\$2743	\$2845	\$2948	\$3050	\$3151	\$3253
		ZONE 3	\$2178	\$2283	\$2388	\$2493	\$2598	\$2703	\$2808	\$2913	\$3018	\$3123	\$3228	\$3333
		ZONE 4	\$2228	\$2336	\$2444	\$2552	\$2661	\$2769	\$2877	\$2985	\$3093	\$3201	\$3309	\$3417
		ZONE 5	\$2280	\$2392	\$2504	\$2615	\$2726	\$2839	\$2950	\$3061	\$3174	\$3285	\$3396	\$3508

Metal with
Wood Trim Base

Approximate Shipping weight: 95 lbs



URBAN COLLECTION

Fully Uph. Arm Loveseats

Seat Construction: Webbing

Wood Species: Solid Beech Hardwood / Engineered Hardwood

SIN # 711-16

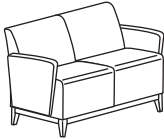
5323W Fully Uph. Arm Love Seat	Dimensions/ Yardage	Zone Grade	COM A	B	COL C	D	E	F	G	H	I	J	K	L
	Outside 52W 27D 32H Inside S/H19 A/H25 5 yd.85 sq. ft.	ZONE 1	\$1647	\$1747	\$1845	\$1945	\$2044	\$2142	\$2242	\$2340	\$2440	\$2539	\$2638	\$2737
		ZONE 2	\$1690	\$1791	\$1893	\$1996	\$2098	\$2200	\$2301	\$2403	\$2505	\$2607	\$2709	\$2811
		ZONE 3	\$1734	\$1839	\$1944	\$2049	\$2154	\$2259	\$2364	\$2469	\$2574	\$2679	\$2784	\$2889
		ZONE 4	\$1782	\$1890	\$1998	\$2106	\$2214	\$2322	\$2431	\$2539	\$2648	\$2756	\$2864	\$2972
		ZONE 5	\$1833	\$1944	\$2055	\$2168	\$2279	\$2390	\$2502	\$2614	\$2725	\$2837	\$2949	\$3060

Solid Wood Base

Approximate Shipping weight: 95 lbs

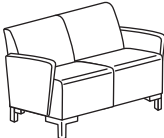
5323-M Fully Uph. Arm Love Seat	Dimensions/ Yardage	Zone Grade	COM A	B	COL C	D	E	F	G	H	I	J	K	L
	Outside 52W 27D 32H Inside S/H19 A/H25 5 yd.85 sq. ft.	ZONE 1	\$1558	\$1656	\$1754	\$1852	\$1950	\$2049	\$2147	\$2245	\$2343	\$2441	\$2540	\$2637
		ZONE 2	\$1597	\$1698	\$1799	\$1900	\$2001	\$2102	\$2203	\$2303	\$2405	\$2506	\$2607	\$2707
		ZONE 3	\$1639	\$1743	\$1847	\$1950	\$2054	\$2158	\$2262	\$2366	\$2470	\$2574	\$2678	\$2781
		ZONE 4	\$1683	\$1790	\$1897	\$2004	\$2112	\$2219	\$2326	\$2433	\$2540	\$2647	\$2754	\$2861
		ZONE 5	\$1730	\$1840	\$1950	\$2061	\$2172	\$2282	\$2392	\$2503	\$2613	\$2723	\$2834	\$2945

Metal Base

Approximate Shipping weight: 95 lbs

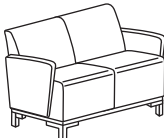
5323-MW Fully Uph. Arm Love Seat	Dimensions/ Yardage	Zone Grade	COM A	B	COL C	D	E	F	G	H	I	J	K	L
	Outside 52W 27D 32H Inside S/H19 A/H25 5 yd.85 sq. ft.	ZONE 1	\$1704	\$1803	\$1903	\$2001	\$2101	\$2200	\$2299	\$2398	\$2497	\$2596	\$2695	\$2794
		ZONE 2	\$1748	\$1851	\$1953	\$2054	\$2156	\$2258	\$2360	\$2461	\$2564	\$2666	\$2768	\$2869
		ZONE 3	\$1795	\$1900	\$2004	\$2109	\$2214	\$2319	\$2424	\$2529	\$2634	\$2739	\$2844	\$2949
		ZONE 4	\$1844	\$1953	\$2061	\$2169	\$2277	\$2385	\$2493	\$2601	\$2709	\$2817	\$2926	\$3034
		ZONE 5	\$1896	\$2009	\$2120	\$2231	\$2343	\$2455	\$2566	\$2678	\$2790	\$2901	\$3013	\$3124

Metal with
Wood Trim Base

Approximate Shipping weight: 95 lbs



URBAN COLLECTION

Benches

Seat Construction: Webbing

Wood Species: Solid Beech Hardwood / Engineered Hardwood

SIN # 711-16

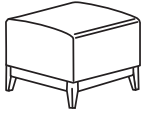
5341W Bench	Dimensions/ Yardage	Zone Grade	COM A	B	COL C	D	E	F	G	H	I	J	K	L
 Solid Wood Base	24W 24D 19H 1.5 yd. 26 sq. ft.	ZONE 1	\$699	\$731	\$764	\$797	\$830	\$863	\$896	\$929	\$961	\$994	\$1027	\$1060
		ZONE 2	\$717	\$750	\$783	\$817	\$851	\$885	\$919	\$952	\$986	\$1020	\$1054	\$1087
		ZONE 3	\$735	\$770	\$805	\$838	\$873	\$908	\$942	\$977	\$1011	\$1046	\$1081	\$1115
		ZONE 4	\$755	\$791	\$826	\$862	\$897	\$932	\$968	\$1003	\$1039	\$1074	\$1110	\$1145
		ZONE 5	\$776	\$812	\$848	\$885	\$921	\$958	\$994	\$1030	\$1067	\$1103	\$1141	\$1177

Approximate Shipping weight: 35 lbs

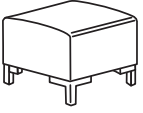
5341-M Bench	Dimensions/ Yardage	Zone Grade	COM A	B	COL C	D	E	F	G	H	I	J	K	L
 Metal Base	24W 24D 19H 1.5 yd. 26 sq. ft.	ZONE 1	\$670	\$703	\$736	\$769	\$801	\$834	\$867	\$900	\$933	\$966	\$999	\$1031
		ZONE 2	\$687	\$721	\$755	\$789	\$822	\$855	\$889	\$923	\$957	\$990	\$1024	\$1058
		ZONE 3	\$705	\$740	\$774	\$809	\$844	\$878	\$913	\$947	\$982	\$1017	\$1050	\$1085
		ZONE 4	\$724	\$760	\$795	\$830	\$866	\$901	\$937	\$972	\$1008	\$1043	\$1079	\$1114
		ZONE 5	\$744	\$780	\$817	\$853	\$889	\$926	\$962	\$1000	\$1036	\$1072	\$1109	\$1145

Approximate Shipping weight: 35 lbs

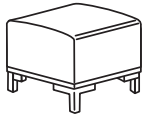
5341-MW Bench	Dimensions/ Yardage	Zone Grade	COM A	B	COL C	D	E	F	G	H	I	J	K	L
 Metal with Wood Trim Base	24W 24D 19H 1.5 yd. 26 sq. ft.	ZONE 1	\$756	\$789	\$822	\$854	\$887	\$920	\$953	\$986	\$1019	\$1052	\$1084	\$1117
		ZONE 2	\$775	\$809	\$842	\$876	\$909	\$943	\$977	\$1010	\$1044	\$1078	\$1112	\$1146
		ZONE 3	\$795	\$830	\$864	\$899	\$933	\$968	\$1003	\$1037	\$1072	\$1106	\$1141	\$1176
		ZONE 4	\$816	\$852	\$887	\$923	\$958	\$994	\$1029	\$1064	\$1100	\$1135	\$1171	\$1206
		ZONE 5	\$838	\$876	\$912	\$948	\$985	\$1021	\$1058	\$1094	\$1131	\$1167	\$1203	\$1240

Approximate Shipping weight: 35 lbs

URBAN COLLECTION

Benches



Seat Construction: Webbing
Wood Species: Solid Beech Hardwood / Engineered Hardwood

SIN # 711-16

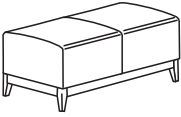
5342W Bench	Dimensions/ Yardage	Zone Grade	COM A	B	COL C	D	E	F	G	H	I	J	K	L
	24W 48D 19H 2 yd. 34 sq. ft.	ZONE 1	\$988	\$1031	\$1075	\$1119	\$1163	\$1206	\$1251	\$1294	\$1338	\$1382	\$1426	\$1469
		ZONE 2	\$1013	\$1058	\$1102	\$1148	\$1193	\$1237	\$1283	\$1327	\$1372	\$1417	\$1462	\$1507
		ZONE 3	\$1039	\$1085	\$1131	\$1178	\$1223	\$1270	\$1315	\$1362	\$1408	\$1454	\$1500	\$1547
		ZONE 4	\$1067	\$1114	\$1162	\$1209	\$1256	\$1304	\$1352	\$1398	\$1446	\$1492	\$1540	\$1588
		ZONE 5	\$1096	\$1145	\$1194	\$1242	\$1291	\$1340	\$1389	\$1437	\$1485	\$1534	\$1583	\$1631

Solid Wood Base

Approximate Shipping weight: 60 lbs

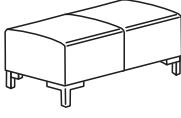
5342-M Bench	Dimensions/ Yardage	Zone Grade	COM A	B	COL C	D	E	F	G	H	I	J	K	L
	24W 48D 19H 2 yd. 34 sq. ft.	ZONE 1	\$876	\$920	\$964	\$1007	\$1052	\$1095	\$1138	\$1183	\$1226	\$1270	\$1314	\$1358
		ZONE 2	\$898	\$943	\$988	\$1034	\$1078	\$1123	\$1168	\$1213	\$1257	\$1303	\$1347	\$1393
		ZONE 3	\$922	\$968	\$1014	\$1060	\$1106	\$1152	\$1198	\$1244	\$1290	\$1337	\$1382	\$1429
		ZONE 4	\$947	\$994	\$1041	\$1089	\$1135	\$1183	\$1231	\$1277	\$1325	\$1373	\$1419	\$1467
		ZONE 5	\$972	\$1021	\$1070	\$1118	\$1167	\$1216	\$1265	\$1313	\$1361	\$1410	\$1459	\$1507

Metal Base

Approximate Shipping weight: 60 lbs

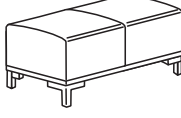
5342-MW Bench	Dimensions/ Yardage	Zone Grade	COM A	B	COL C	D	E	F	G	H	I	J	K	L
	24W 48D 19H 2 yd. 34 sq. ft.	ZONE 1	\$1029	\$1073	\$1117	\$1161	\$1204	\$1249	\$1292	\$1336	\$1380	\$1424	\$1467	\$1512
		ZONE 2	\$1056	\$1100	\$1146	\$1190	\$1235	\$1280	\$1325	\$1370	\$1415	\$1460	\$1504	\$1550
		ZONE 3	\$1083	\$1129	\$1176	\$1221	\$1268	\$1313	\$1360	\$1406	\$1452	\$1498	\$1544	\$1590
		ZONE 4	\$1112	\$1160	\$1206	\$1254	\$1302	\$1348	\$1396	\$1444	\$1490	\$1538	\$1586	\$1632
		ZONE 5	\$1143	\$1191	\$1240	\$1289	\$1337	\$1385	\$1434	\$1483	\$1532	\$1580	\$1629	\$1678

Metal with
Wood Trim Base

Approximate Shipping weight: 60 lbs

URBAN COLLECTION

Benches



Seat Construction: Webbing

Wood Species: Beech Hardwood / Engineered Hardwood

SIN # 711-16

5343W Bench	Dimensions/ Yardage	Zone Grade	COM A	B	COL C	D	E	F	G	H	I	J	K	L
 33W 33D 19H 2.25 yd. 39 sq. ft.		ZONE 1	\$1129	\$1179	\$1227	\$1277	\$1326	\$1376	\$1425	\$1473	\$1523	\$1572	\$1622	\$1671
		ZONE 2	\$1158	\$1208	\$1259	\$1309	\$1360	\$1411	\$1461	\$1512	\$1562	\$1612	\$1663	\$1714
		ZONE 3	\$1188	\$1240	\$1291	\$1343	\$1395	\$1447	\$1499	\$1551	\$1603	\$1655	\$1707	\$1759
		ZONE 4	\$1220	\$1273	\$1326	\$1379	\$1433	\$1486	\$1539	\$1592	\$1645	\$1699	\$1752	\$1805
		ZONE 5	\$1253	\$1308	\$1363	\$1417	\$1472	\$1526	\$1582	\$1637	\$1691	\$1746	\$1800	\$1855

Solid Wood Base

Approximate Shipping weight: 55 lbs

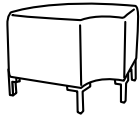
5343-M Bench	Dimensions/ Yardage	Zone Grade	COM A	B	COL C	D	E	F	G	H	I	J	K	L
 33W 33D 19H 2.25 yd. 39 sq. ft.		ZONE 1	\$925	\$974	\$1024	\$1073	\$1123	\$1171	\$1221	\$1270	\$1320	\$1368	\$1418	\$1467
		ZONE 2	\$949	\$1000	\$1049	\$1100	\$1151	\$1201	\$1252	\$1303	\$1353	\$1403	\$1454	\$1504
		ZONE 3	\$973	\$1025	\$1077	\$1129	\$1181	\$1233	\$1285	\$1337	\$1389	\$1441	\$1492	\$1544
		ZONE 4	\$1000	\$1053	\$1107	\$1160	\$1213	\$1266	\$1319	\$1373	\$1426	\$1479	\$1532	\$1586
		ZONE 5	\$1027	\$1082	\$1136	\$1191	\$1246	\$1301	\$1356	\$1410	\$1465	\$1519	\$1574	\$1629

Metal Base

Approximate Shipping weight: 55 lbs

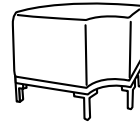
5343-MW Bench	Dimensions/ Yardage	Zone Grade	COM A	B	COL C	D	E	F	G	H	I	J	K	L
 33W 33D 19H 2.25 yd. 39 sq. ft.		ZONE 1	\$1123	\$1171	\$1221	\$1270	\$1320	\$1368	\$1418	\$1467	\$1517	\$1566	\$1615	\$1664
		ZONE 2	\$1151	\$1201	\$1252	\$1303	\$1353	\$1403	\$1454	\$1504	\$1555	\$1606	\$1657	\$1707
		ZONE 3	\$1181	\$1233	\$1285	\$1337	\$1389	\$1441	\$1492	\$1544	\$1595	\$1647	\$1699	\$1751
		ZONE 4	\$1213	\$1266	\$1319	\$1373	\$1426	\$1479	\$1532	\$1586	\$1639	\$1692	\$1745	\$1798
		ZONE 5	\$1246	\$1301	\$1356	\$1410	\$1465	\$1519	\$1574	\$1629	\$1683	\$1738	\$1794	\$1848

Metal with
Wood Trim Base

Approximate Shipping weight: 55 lbs



URBAN COLLECTION

Corner Lounge

Seat Construction: Webbing

Wood Species: Beech Hardwood / Engineered Hardwood

SIN # 711-16

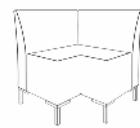
5324-M Corner Loungr	Dimensions/ Yardage	Zone Grade	COM A	B	COL C	D	E	F	G	H	I	J	K	L
 33W 33D 32H 2.25 yd. 39 sq. ft.		ZONE 1	\$1123	\$1171	\$1221	\$1270	\$1320	\$1368	\$1418	\$1467	\$1517	\$1566	\$1615	\$1664
		ZONE 2	\$1151	\$1201	\$1252	\$1303	\$1353	\$1403	\$1454	\$1504	\$1555	\$1606	\$1657	\$1707
		ZONE 3	\$1181	\$1233	\$1285	\$1337	\$1389	\$1441	\$1492	\$1544	\$1595	\$1647	\$1699	\$1751
		ZONE 4	\$1213	\$1266	\$1319	\$1373	\$1426	\$1479	\$1532	\$1586	\$1639	\$1692	\$1745	\$1798
		ZONE 5	\$1246	\$1301	\$1356	\$1410	\$1465	\$1519	\$1574	\$1629	\$1683	\$1738	\$1794	\$1848

Metal Base

Approximate Shipping weight: 55 lbs

URBAN COLLECTION

Tables



Wood Species: Beech Hardwood / Engineered Hardwood

SIN # 711-16

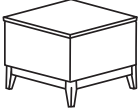
5351W Table	Dimensions/ Yardage	Zone Grade	COM A	B	COL C	D	E	F	G	H	I	J	K	L
 Solid Wood Base	24W 24D 18H 1.25 yd. 22 sq. ft.	ZONE 1	\$969	\$986	\$1002	\$1019	\$1035	\$1052	\$1067	\$1084	\$1100	\$1117	\$1133	\$1150
		ZONE 2	\$994	\$1010	\$1027	\$1044	\$1061	\$1078	\$1095	\$1112	\$1129	\$1146	\$1162	\$1179
		ZONE 3	\$1020	\$1037	\$1055	\$1072	\$1089	\$1106	\$1124	\$1141	\$1158	\$1176	\$1193	\$1209
		ZONE 4	\$1047	\$1064	\$1082	\$1100	\$1118	\$1135	\$1153	\$1171	\$1189	\$1206	\$1224	\$1242
		ZONE 5	\$1076	\$1094	\$1112	\$1131	\$1149	\$1167	\$1185	\$1203	\$1222	\$1240	\$1258	\$1276

Approximate Shipping weight: 50 lbs

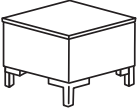
5351-M Table	Dimensions/ Yardage	Zone Grade	COM A	B	COL C	D	E	F	G	H	I	J	K	L
 Metal Base	24W 24D 18H 1.25 yd. 22 sq. ft.	ZONE 1	\$871	\$914	\$957	\$1000	\$1041	\$1084	\$1127	\$1170	\$1213	\$1256	\$1299	\$1340
		ZONE 2	\$893	\$937	\$982	\$1026	\$1069	\$1112	\$1156	\$1200	\$1244	\$1287	\$1331	\$1375
		ZONE 3	\$917	\$962	\$1006	\$1052	\$1097	\$1141	\$1187	\$1231	\$1277	\$1322	\$1365	\$1411
		ZONE 4	\$941	\$988	\$1034	\$1079	\$1126	\$1171	\$1218	\$1264	\$1310	\$1356	\$1403	\$1448
		ZONE 5	\$967	\$1014	\$1062	\$1109	\$1156	\$1204	\$1251	\$1300	\$1347	\$1394	\$1442	\$1489

Approximate Shipping weight: 50 lbs

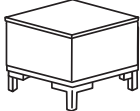
5351-MW Table	Dimensions/ Yardage	Zone Grade	COM A	B	COL C	D	E	F	G	H	I	J	K	L
 Metal with Wood Trim Base	24W 24D 18H 1.25 yd. 22 sq. ft.	ZONE 1	\$993	\$1009	\$1026	\$1042	\$1059	\$1075	\$1092	\$1108	\$1125	\$1141	\$1158	\$1173
		ZONE 2	\$1019	\$1036	\$1053	\$1068	\$1085	\$1102	\$1119	\$1136	\$1153	\$1170	\$1187	\$1204
		ZONE 3	\$1045	\$1062	\$1079	\$1097	\$1114	\$1131	\$1149	\$1166	\$1183	\$1201	\$1218	\$1235
		ZONE 4	\$1073	\$1091	\$1109	\$1127	\$1144	\$1162	\$1180	\$1197	\$1215	\$1233	\$1251	\$1268
		ZONE 5	\$1102	\$1120	\$1140	\$1158	\$1176	\$1194	\$1212	\$1231	\$1249	\$1267	\$1285	\$1303

Approximate Shipping weight: 50 lbs



URBAN COLLECTION Tables

Wood Species: Beech Hardwood / Engineered Hardwood

SIN # 711-16

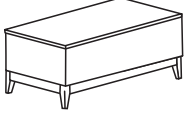
5352W Table	Dimensions/ Yardage	Zone Grade	COM A	B	COL C	D	E	F	G	H	I	J	K	L
 Solid Wood Base	24W 48D 18H 1.25 yd. 22 sq. ft.	ZONE 1	\$1291	\$1319	\$1346	\$1373	\$1400	\$1428	\$1455	\$1483	\$1511	\$1537	\$1565	\$1592
		ZONE 2	\$1324	\$1352	\$1380	\$1408	\$1436	\$1464	\$1492	\$1520	\$1549	\$1576	\$1605	\$1632
		ZONE 3	\$1359	\$1388	\$1416	\$1445	\$1473	\$1502	\$1532	\$1560	\$1589	\$1618	\$1646	\$1675
		ZONE 4	\$1395	\$1425	\$1454	\$1484	\$1513	\$1542	\$1572	\$1602	\$1631	\$1661	\$1691	\$1720
		ZONE 5	\$1433	\$1464	\$1494	\$1524	\$1555	\$1585	\$1615	\$1646	\$1676	\$1707	\$1737	\$1767

Approximate Shipping weight: 90 lbs

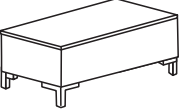
5352-M Table	Dimensions/ Yardage	Zone Grade	COM A	B	COL C	D	E	F	G	H	I	J	K	L
 Metal Base	24W 48D 18H 1.25 yd. 22 sq. ft.	ZONE 1	\$1151	\$1179	\$1205	\$1233	\$1260	\$1288	\$1315	\$1343	\$1370	\$1397	\$1425	\$1452
		ZONE 2	\$1180	\$1208	\$1236	\$1265	\$1292	\$1321	\$1348	\$1377	\$1405	\$1433	\$1461	\$1489
		ZONE 3	\$1211	\$1240	\$1269	\$1297	\$1326	\$1355	\$1383	\$1413	\$1442	\$1470	\$1499	\$1527
		ZONE 4	\$1243	\$1273	\$1303	\$1332	\$1362	\$1392	\$1420	\$1450	\$1480	\$1509	\$1539	\$1569
		ZONE 5	\$1277	\$1308	\$1339	\$1368	\$1399	\$1430	\$1460	\$1490	\$1521	\$1551	\$1582	\$1612

Approximate Shipping weight: 90 lbs

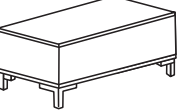
5352-MW Table	Dimensions/ Yardage	Zone Grade	COM A	B	COL C	D	E	F	G	H	I	J	K	L
 Metal with Wood Trim Base	24W 48D 18H 1.25 yd. 22 sq. ft.	ZONE 1	\$1304	\$1331	\$1359	\$1386	\$1414	\$1442	\$1468	\$1496	\$1523	\$1551	\$1578	\$1605
		ZONE 2	\$1338	\$1365	\$1394	\$1421	\$1450	\$1478	\$1506	\$1534	\$1562	\$1590	\$1618	\$1646
		ZONE 3	\$1373	\$1401	\$1430	\$1459	\$1487	\$1516	\$1545	\$1574	\$1603	\$1631	\$1660	\$1689
		ZONE 4	\$1409	\$1438	\$1468	\$1498	\$1527	\$1557	\$1587	\$1617	\$1645	\$1675	\$1704	\$1734
		ZONE 5	\$1448	\$1478	\$1508	\$1539	\$1570	\$1600	\$1630	\$1661	\$1691	\$1721	\$1752	\$1782

Approximate Shipping weight: 90 lbs

URBAN COLLECTION Tables

Wood Species: Beech Hardwood / Engineered Hardwood

SIN # 711-16

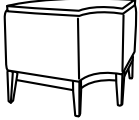

5353W Table	Dimensions/ Yardage	Zone Grade	COM A	B	COL C	D	E	F	G	H	I	J	K	L
 Solid Wood Base	33W 33D 18H 1.5 yd.26 sq. ft.	ZONE 1	\$1559	\$1592	\$1625	\$1658	\$1691	\$1724	\$1756	\$1789	\$1822	\$1855	\$1888	\$1921
		ZONE 2	\$1598	\$1632	\$1666	\$1700	\$1734	\$1767	\$1801	\$1835	\$1869	\$1902	\$1936	\$1969
		ZONE 3	\$1641	\$1675	\$1710	\$1745	\$1779	\$1814	\$1848	\$1883	\$1918	\$1951	\$1986	\$2021
		ZONE 4	\$1684	\$1720	\$1755	\$1791	\$1826	\$1862	\$1897	\$1933	\$1968	\$2004	\$2039	\$2075
		ZONE 5	\$1731	\$1767	\$1804	\$1840	\$1877	\$1913	\$1949	\$1986	\$2022	\$2060	\$2096	\$2132

Approximate Shipping weight: 75 lbs

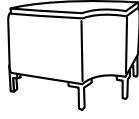
5353-M Table	Dimensions/ Yardage	Zone Grade	COM A	B	COL C	D	E	F	G	H	I	J	K	L
 Metal Base	33W 33D 18H 1.5 yd.26 sq. ft.	ZONE 1	\$1191	\$1224	\$1257	\$1290	\$1323	\$1356	\$1389	\$1421	\$1454	\$1487	\$1520	\$1553
		ZONE 2	\$1222	\$1255	\$1289	\$1323	\$1357	\$1390	\$1424	\$1458	\$1491	\$1525	\$1558	\$1592
		ZONE 3	\$1254	\$1288	\$1323	\$1357	\$1392	\$1427	\$1461	\$1496	\$1530	\$1565	\$1600	\$1633
		ZONE 4	\$1287	\$1323	\$1358	\$1394	\$1429	\$1465	\$1500	\$1536	\$1571	\$1607	\$1642	\$1678
		ZONE 5	\$1323	\$1359	\$1396	\$1432	\$1468	\$1505	\$1541	\$1578	\$1614	\$1650	\$1688	\$1724

Approximate Shipping weight: 75 lbs

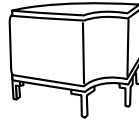
5353-MW Table	Dimensions/ Yardage	Zone Grade	COM A	B	COL C	D	E	F	G	H	I	J	K	L
 Metal with Wood Trim Base	33W 33D 18H 1.5 yd.26 sq. ft.	ZONE 1	\$1477	\$1509	\$1542	\$1575	\$1608	\$1641	\$1674	\$1707	\$1738	\$1771	\$1804	\$1837
		ZONE 2	\$1514	\$1548	\$1582	\$1614	\$1648	\$1682	\$1716	\$1749	\$1783	\$1817	\$1851	\$1885
		ZONE 3	\$1553	\$1588	\$1622	\$1657	\$1692	\$1726	\$1761	\$1795	\$1830	\$1865	\$1898	\$1933
		ZONE 4	\$1594	\$1630	\$1665	\$1701	\$1736	\$1772	\$1807	\$1843	\$1878	\$1914	\$1949	\$1985
		ZONE 5	\$1639	\$1675	\$1712	\$1748	\$1784	\$1821	\$1857	\$1894	\$1930	\$1967	\$2003	\$2039

Approximate Shipping weight: 75 lbs

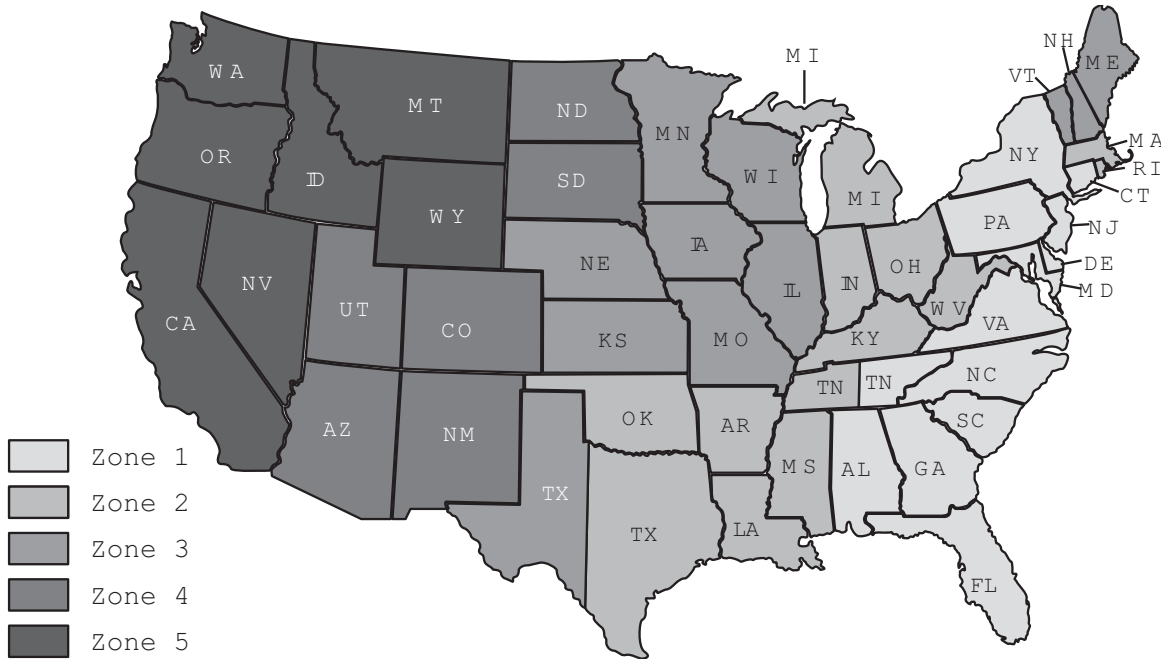

ZONE 1

- ALABAMA
- CONNECTICUT
- DELAWARE
- DISTRICT OF COLUMBIA
- FLORIDA
- GEORGIA
- MARYLAND
- NEW JERSEY
- NEW YORK
- NORTH CAROLINA
- PENNSYLVANIA
- SOUTH CAROLINA
- TENNESSEE (EAST)
- VIRGINIA

ZONE 2

- ARKANSAS
- INDIANA
- KENTUCKY
- LOUISIANA
- MASSACHUSETTS
- MICHIGAN
- MISSISSIPPI
- OHIO
- OKLAHOMA
- RHODE ISLAND
- WEST VIRGINIA
- TENNESSEE (WEST)
- TEXAS (EAST)

ZONE 3

- ILLINOIS
- IOWA
- KANSAS
- MAINE
- MINNESOTA
- MISSOURI
- NEBRASKA
- NEW HAMPSHIRE
- VERMONT
- WISCONSIN
- TEXAS (WEST)

ZONE 4

- ARIZONA
- COLORADO
- NEW MEXICO
- NORTH DAKOTA
- SOUTH DAKOTA
- UTAH

ZONE 5

- CALIFORNIA
- IDAHO
- MONTANA
- NEVADA
- OREGON
- WASHINGTON
- WYOMING

1. All list prices are F.O.B.- Factory freight prepaid and allowed to one destination. All orders are priced according to the zones listed above. The zone is determined by the “ship to” destination. All prices listed are for shipments within the continental United States. Export and shipments to Alaska and Hawaii are freight prepaid and allowed to port of exit.
2. HC reserves the right to select the appropriate carrier for all shipments.
3. Special requests including but not limited to inside delivery residential delivery installation and call before delivery are not included in prices shown and are the responsibility of the dealer.
4. Any charges arising from failure to meet shipment rerouting

while in transit or carrier storage charges are the responsibility of the dealer.

5. Orders of less than 150 lbs. will be assessed a per order NET handling charge. This charge will be waived for items shipped via UPS.

Zone 1	- \$55	Zone 4	- \$80
Zone 2 & 3	- \$65	Zone 5	- \$95

6. HC will make every effort to ship orders complete but reserves the right to part ship when necessary.

TRANSPORTATION CLAIMS

All furniture is carefully inspected and cartoned according to trucking and railroad requirements. The transportation company assumes full responsibility upon acceptance of the shipment. If shipment arrives damaged:

- Note any visible loss or damage on freight bill
- In case of concealed loss or damage notify transportation company immediately and file “Concealed Damage” claim. This should be done within 5 days of receipt of furniture.
- Be sure to retain the carton and packaging for inspection because the carton may not show outside damage.
- Take photos of damage and notify HC.

TERMS AND CONDITIONS



GENERAL

All orders must be made in writing; faxed to 704.462.2672, mailed to: HC 7514 West NC #10 Hwy Vale NC 28168 or emailed to info@hlc-usa.com.

Possession of this price list does not constitute an offer to sell.

Orders can only be received from Authorized HC Dealers.

Prices shown in this price list are subject to change without notice. Should a typographical error be found HC reserves the right to make changes.

All Dimensions/s shown in this price list are approximate and subject to variation.

TERMS

NET 30 DAYS. Please make payments for HC invoices to HC. All new account orders must be submitted to HC for approval. HC suggests current financial information for new customers to accompany their initial order to avoid approval delays. Allow two to three weeks for the credit approval process.

A 50% deposit payable to HC with your first order will expedite your shipment while credit is being established. All custom orders will require a 50% deposit payable to HC with the order.

ACKNOWLEDGEMENTS

Order acknowledgments will be made for each order and will indicate final production specifications. Buyers should check acknowledgments to be sure that all order details are correct. Orders will not be acknowledged or entered for production until all specification information is complete. Accepted orders are subject to terms and conditions set forth in this price list and on our acknowledgment. This supersedes any variance in terms and conditions on buyer's purchase order.

HC is not liable for any delays or failure to deliver or perform due to fires floods accidents transportation difficulties failure due to delay of sources of supply acts of God or any other causes of like or unlike nature beyond HC's control.

WAREHOUSING

As production space is at a premium orders will be shipped when completed. Any date other than such date must be approved by the factory. If an order is required to be warehoused due to buyer's request a charge will be levied for such (chairs and ottomans - \$20 list per week lounge chairs love seats and sofas - \$45 list per week). All orders being warehoused will be invoiced at normal time of shipping and paid for under normal terms and conditions. Failure of such could affect credit line.

PRODUCT SPECIFICATIONS

DESIGN

HC reserves the right to make changes in design or construction detail without notice; therefore if it is desired that an order match an order previously shipped it must be clearly stated on your purchase order.

MODIFICATIONS/CUSTOMS

HC has the ability to modify existing products and/or manufacture custom products. Please contact factory for information. This includes OEM Products Frames and Parts. All non-standard HC products have a one year limited warranty. Custom orders require a 50% deposit at time of order placement.

FRAME CONSTRUCTION

CANCELLATION

Any order cancelled after it has been placed into production will be subject to a cancellation charge. This charge will be determined by HC based upon where the order is in production at time of cancellation request.

HC will make every effort to meet acknowledged shipping dates. However failure to meet such a date is not cause for cancellation.

WARRANTY

HC warrants to the original buyer that each piece of HC product will be free from defects in workmanship given normal use and care for ten years of single shift service except where noted in this price list.

HC assumes no responsibility for improper assembly modification abuse alteration negligent use or unauthorized repair work by the buyer.

This warranty does not cover: damage caused by a carrier; C.O.M. or C.O.L.; gas cylinder-pneumatic lifts casters and mechanisms beyond the OEM warranty; color grain or texture of woods and other covering materials due to natural variations over which HC has no control.

HC does not offer warranty on textiles beyond what is offered by the supplier.

HC will either replace or repair at our option any parts of the product found to be defective within the terms of warranty. Such is the buyer's sole remedy. HC shall not be liable for consequential or incidental damage to persons or property.

Except as stated herein HC makes no expressed or implied warranties of merchantability or fitness of any HC product for any particular purpose.

All non-standard HC products have a one year limited warranty. All repair charges must be authorized in writing by HC for warranty work. Only after receipt of repair bill from party performing repairs will a credit or reimbursement take place. Do not return any merchandise without written permission from HC. Only warranted product will be considered.

Light finishes tend to highlight rather than mask the natural characteristics and color variation of wood which are not considered defects by HC. Likewise leather is characterized by variation in color from hide to hide and within hides and should be expected. Healed scars scratches insect bites and wrinkles are not considered defects in the leather.

WARNING

Direct sunlight can fade finishes leathers and upholstery; and can dry out leather and degrade some vinyl covers. HC cannot control nor be held responsible for sunlight damage.

PRODUCT SPECIFICATIONS

Our wood lounge frames are bench made exclusively in North Carolina by local craftsmen who have been building furniture in this area for generations. We use only kiln-dried Beech or beech hardwood (5/4 size minimum) or durable engineered wood panels crafted of multilayered solid wood veneers to reduce movement, twisting and warping. Key joints are reinforced with traditional double dowels, corner blocks and interlocking joints to withstand weight and stress. Exposed wood furnishings are handcrafted of the finest Beech or beech hardwoods. Rails are double doweled and corner blocked for maximum strength. All corner blocks are screwed and/or stapled to insure strength.

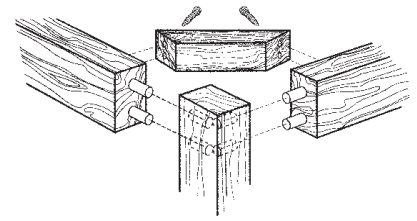

SPRING AND SEAT CONSTRUCTION

HC's primary spring and seat construction is the eight-way hand tied system. When eight-way construction is not possible due to design HC will use an appropriate seat construction based on industry standards.

- **Eight-Way Hand Tied System**

The best spring construction available when chair design allows. Provides comfort and long life by utilizing double coil springs tied to each other and frame rails. This allows springs to move only in a vertical motion and distribute weight load equally to chair rails.

Materials

- Eight and nine gauge solid carbon steel double coil springs.
- 100% waxed #6 nylon string.
- Eight knots per coil at top.
- Paper lined steel fastener secures coil to bottom.
- 54 strands/inch #650 Woven Poly Propex bottom.
- 7/8" steel nails attach strings to rails.
- System covered with FLW Polywoven material.

- **Rubber Webbing System**

Simple spring construction for Contemporary and Transitional seating that require very thin scaled designs. Provides comfort and strength by attaching rubber webbing from the front rail to the back rail and across seat from side rails.

Materials

- Ultraflex Type #550 rubber webbing 2" wide with 20% stretch load
- #10 steel staples attach webbing to frame rails.

- **No Sag System**

The best spring construction for designs that do not allow for eight way hand tied system. Used on most Contemporary and Transitional style seating and as a cost savings on Traditional style seating. Provides comfort and strength by using sinuous wire springs that are connected to front and back rails. These springs are then held together by a coated wire clipped to each spring.

Materials

- Eight and ten gauge sinuous wire springs in continuous 2" wide loops. These springs are spread 4" on center across seat.
- Coated stabilizing wire.
- System covered with FLW Polywoven material.

- **Foam Over Propex**

Simple seat construction for Contemporary and Transitional seating that require very thin scaled designs. Provides comfort and strength by attaching Polywoven propex material to all four side rails then covering with foam.

Materials

- #650 woven poly propex with 54 strands per sq. inch
- 500 7/16" steel staples attach propex to rails.

MECHANISMS

- **Manual Swivel Tilt Control** - Used for medium and large fixed back tilting chairs this spring control employs a low fulcrum and a dual "floating spring" concept to ensure both a balanced and stable ride throughout the full tilting range. Nylon contacts rubber cushion shock absorbers and self-lubricating fiberglass reinforced nylon bearings provide for long lasting quality.

Adjustments: A. Tilt tension control knob
B. Manual height adjustment

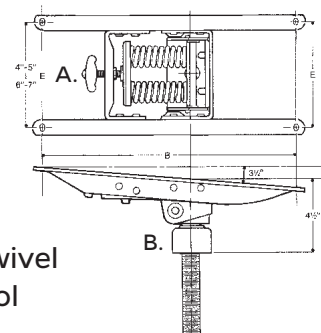

Typical Swivel
Tilt Control

PRODUCT SPECIFICATIONS

MECHANISMS (continued)

- Knee Tilt Controls - Used for fixed back tilting chairs the forward positioning of the fulcrum permits the chair to tilt back from the front edge. This results in minimum vertical knee movement alleviates upward thigh pressure and improves access to lower desk areas. Its streamlined design and construction exceeds ANSI/BIFMA standards and offers permanently lubricated reinforced nylon bearings. This mechanism is offered with either mechanical or pneumatic height adjustment.

Adjustments: A. Tilt tension control knob
B. Pneumatic height adjustment lever
C. Manual height adjustment
D. Tilt lock push/pull rod

Typical Knee
Tilt Control

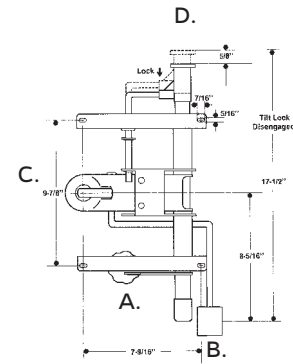

BASES

Bases E and L are constructed with solid steel understructures and solid hardwood base caps. Base P is cast fiberglass reinforced nylon.



E - \$225



L - \$200



P - \$65

PRODUCT SPECIFICATIONS

FINISHES

HC has eight key steps in the finishing process. These steps and the use of a catalyzed lacquer provide all products with a high quality long lasting finish. The steps are as follows:

1. Primary Machine Sand 100-120 Grit
2. Secondary Hand Sand 150-220 Grit
3. Apply Stain
4. Apply Sealer
5. Sand 280 Grit
6. Apply First Coats of Catalyzed Lacquer
7. Sand 320 Grit
8. Apply Second Coats of Catalyzed Lacquer

HC applies the finishes listed below to exposed beech/maple hardwood. If a different species of wood is required please contact the factory for price and availability.

Standard Finishes

Hickory Contract offers 10 standard wood grain finishes and 10 laminate choices. You may view these selections on line or inquire with customer service for samples.

Mahogany	Cherry
Walnut	Light Cherry
Black	Natural Maple
P. Mahogany	Pecan*
Oak	Kona

Light Finishes

HC offers several light finishes and custom matches many. These finishes do not hide or mask the natural characteristics of the wood. Both dealer and customer should understand that the natural characteristics of the wood will be a characteristic of the product. Natural characteristics of the product include the natural discoloration of the wood substance and color variations in glued up stock. These natural characteristics are not considered defects by HC and therefore will not warrant replacement or repair.

Custom Finishes

Hickory Contract will match other manufacturers finishes. Please submit a sample with your purchase order. Hickory Contract will have sole discretion concerning the correctness of the match unless an approval samples is requested and approved. The charges for custom finishes are as follows:

\$250 LIST per order
\$125 LIST per approval

The beauty of the wood is the result of natural variations in color and grain. Since no two trees are exactly alike, all woods may vary in color, grain configuration and stain acceptance. Therefore, even though veneers and solids are carefully selected, an exact matching of color and grain cannot be guaranteed.

WELT GUARDS

A 10" long clear Polyvinyl welt guard is standard on all Traditional Executive Swivel Chairs. Please note on order if guard should be deleted.

COMBINATIONS/CONTRASTING WELTS

For contrasting welts or contrasting fabrics please add \$25.00 list/chair \$35.00 list/loveseat and \$45.00 list/sofa.

FIRE RETARDANT CODES

Most products are manufactured to meet California Technical Bulletin 117. HC can manufacture its product with components which should allow the product to meet California Technical Bulletin 133 Requirements. Please contact the factory for pricing. Should certification be required customer is responsible for cost of sample and testing fees.

CUSHION TIE STRAPS

For tie straps which prevent lounge cushions from being easily removed add \$40.00 list/chair \$120.00 list/loveseat and \$160 list/sofa.

LUMBAR BACKS

Additional lumbar support is available on many products. Please consult product pricing pages or the factory for availability and charge.

LEATHER

No two pieces of leather furniture are exactly the same. Color variations and distinctive natural markings make each piece of leather furniture unique.

Color variation is a natural occurrence with pure aniline dyed top grain leathers. In the dying process no pigments are used. Each hide absorbs "color" in varying amounts based on individual cell structure so even areas within the same hide may vary in color.

Color variation is an inherent quality of the antiquing process in hand antiqued leather.

Healed scars scratches insect bites and wrinkles provide yet another Dimensions/ of individuality to leather. All of the above are natural characteristics of leather and are not considered defects by HC.

NAILHEADS

The standard nailhead offered on all Hickory Contract furniture is a ½" French Natural (brass). We offer at no additional charge 5 other choices. You may view these selections on our website or contact customer service for additional information.

CUSTOMER'S OWN MATERIAL

CUSTOMER'S OWN MATERIAL (C.O.M)

All items are available with material furnished by the purchaser and should be priced in grade A. Yardage requirements listed in our price list are based on 54" wide plain material. Generally additional yardage is required if striped or patterned material is used if pattern requires matching or if width of materials is less than 54" wide. HC strongly recommends a sample of the C.O.M. material be submitted for review and approval prior to ordering. We can take no responsibility for tailoring wearability or application of C.O.M. covers.

TEXTILE GRADING

COM should be priced in Grade "A". COL should be priced in Grade "C". COM COL and all leather grades are noted in header above each products zoned pricing.

C.O.M CHART

Though every effort has been made to estimate excess yardage required for stripes and matches HC takes no responsibility where additional material must be ordered. HC will supply yardage requirements for large quantities revisions and special match upon request.

Refer to the following guideline when figuring C.O.M. requirements:

Railbanded							
Fabric Width	Plain Fabric	Repeat					
		1-5"	6-9"	10-13"	14-20"	21-27"	28-34"
54"	0%	+10%	+15%	+20%	+25%	+30%	+35%
50"	+15%	+15%	+20%	+25%	+30%	+35%	+40%
48"	+20%	+20%	+25%	+30%	+35%	+40%	+45%

"Railroad" or "Top to Selvage"

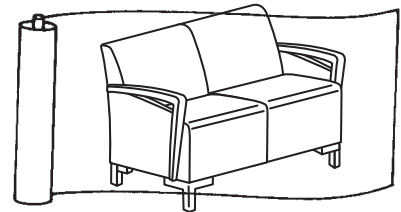

Up The Roll							
Fabric Width	Plain Fabric	Repeat					
		1-5"	6-9"	10-13"	14-20"	21-27"	28-34"
54"	0%	+15%	+18%	+25%	+30%	+35%	+40%
50"	+15%	+20%	+25%	+30%	+35%	+40%	+45%
48"	+20%	+25%	+30%	+35%	+40%	+45%	+50%

Up the Roll

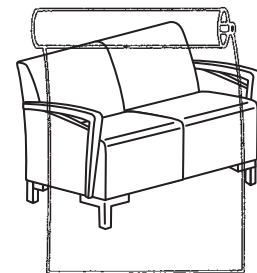

ALL C.O.M.'s AND C.O.L.'s

In absence of specific written instructions accompanying the order fabrics will be cut seamed and applied at HC's discretion and at customer's risk. While HC inspects fabrics for mill imperfections some are difficult to recognize. HC cannot be responsible for defects color inaccuracies dye lot variations/flaws and suggests that our customer inspect fabrics before furnishing them to the factory. HC will make a concentrated effort to control C.O.M. and C.O.L. materials. It is not HC's responsibility to police the receipt of C.O.M. and C.O.L. material in order to meet delivery deadlines and we assume that customers are aware of any undue delay in the delivery of their C.O.M. and C.O.L. materials. All C.O.M. and C.O.L. must be clearly tagged with customer name/ Purchase Order Number/Product Number.

SHIP C.O.M. PREPAID

HC
7514 West NC #10 Hwy.
Vale NC 28168 ATTN: COM/COL Dept.

HC TEXTILE PROGRAMS

HC's textile program offers five types of leathers and over 10,000 different choices of fabrics and vinyls. For grading information, please visit our website at www.HickoryContract.com and visit the textile page.

MAYER

The entire Mayer line is available through HC. For free memo samples call Mayer Fabrics at 800-428-4415. www.mayerfabrics.com



ULTRA FABRICS

The entire Ultra Fabrics line is available through HC. For fabric samples call 877.309.6648. www.ultrafabricsllc.com



MOMENTUM

The entire Momentum line is available through HC. For free memo samples call Momentum at 800-366-6839. www.memosamples.com



DOUGLAS

The entire Douglas line is available through HC. For fabric samples please call 800.950.3684. www.douglassfabrics.com



CF STINSON

The entire CF Stinson line is available through HC. For free memo samples, contact CF Stinson at 800-841-6279



CULP FABRICS

The entire Culp Fabrics line is available through HC. For fabric samples call 336-888-6274. culpcontract.com



HC LEATHER PROGRAMS

RIO

RIO is the go to leather when the demand for durability and value are the top priority. The color options are a minimalist approach that is current and relevant. RIO is dyed for color then pigmented to provide color consistency and a protective finish which is perfect for high traffic areas.

BELLA

Casual elegance and a large color palette make BELLA an easy choice when selecting leather. This color consistent and durable upholstery leather provides a soft drape and hand that tailors exceptionally well. Produced on select European hides this collection provides a premium quality at an affordable grade. BELLA is specified to meet the requirements for contract and hospitality uses.

SANTA FE

SANTA FE is a smart choice for the customer looking for a wax/crackle leather that won't easily scratch. SANTA FE provides that desirable vintage look but offers a protective finish making it suitable for high traffic area. Each hide is aniline dyed and receives a special protective wax top coat for durability and softness. Due to the inherent nature of this raw material, scratches, bruises, scars and insect bites may be noticeable but only add to the richness of this vintage leather.

AVALON

Avalon is a top grain, lightly corrected semi-aniline leather Powered by Crypton, which is bleach cleanable, antimicrobial, antibacterial and stain resistant. Fully aniline dyed and highlighted by a pebble grain, Avalon is available in 25 design driven colors. Durable and ideally suited for healthcare and hospitality applications, Avalon is environmentally friendly and solvent free.

HEIRLOOM

All of the beauty that makes an antique leather desirable is offered in HEIRLOOM at a value price. The subtle hand-wipe effect adds dramatic color depth and produces a two-tone look that is ageless and inviting.

VINTAGE

VINTAGE is a domestic top grain, aniline dyed leather that features Old World craftsmanship of a hand rubbed antiqued finish and is frequently referred to as a glazed leather because of its high sheen. The authentic hand antiquing gives this fine leather its distinctive and unique look. Environmentally friendly, Vintage is available in 9 relevant colors and is an excellent hand antiqued leather choice for the discriminating contract customer.



HC ENVIRONMENTAL POLICY

HC's environmental effort begins by designing and building durable products backed by a ten year warranty. This is a goal aimed at preserving natural resources. It means our products limit the "dispose and repurchase" cycle that constantly burdens our environment with used and wasted furniture.

The safety of employees the community and environmental factors are also considered in the design of products and all production processes. HC's two manufacturing facilities function in full compliance with all applicable EPA and OSHA regulations.

HC identifies the environmental aspects of its business activities manufacturing operations products and services and then strives to prevent or reduce environmental impacts within our control including application of the best available technology and management practices.

HC's Environmental Policy and Goals include:

- Hardwoods from suppliers who practice conservation and reforestation programs not utilizing wood species from endangered rain forests
- Parts manufactured by approved suppliers who apply modern technologies that are not harmful to the environment
- Beech frame construction which is free of formaldehyde often used by others utilizing plywood in their construction
- Technology that maximizes the best and highest quality yield
- Chemicals and adhesives that are formulated to meet or exceed environmental standards
- Alternate packaging methods such as blanket wrapping to reduce use of cardboard packaging
- Transportation management system that contracts with trucking lines who efficiently time shipments to ensure as full as possible shipments to conserve energy
- Maximize use of recyclable packaging materials
- Many recycled materials in the operation of the administrative promotional and financial activities that occur in the operation of HC's daily business

HC also employs processes and materials that prevent reduce or minimize pollution. This includes control mechanisms material substitution efficient use of resources and recycling.

HC will continually explore creative responsible ways to do business and manufacture products so as to better preserve our natural resources and protect the environment for future generations.