

hickory contract

Conference Pricebook

2017



CONFERENCE TABLES



Wood Species: Hardwood Top
Beech Base

SIN # 711-11

425 Round Table	Dimensions	Zone Grade	Price
	21H 42D	ZONE 1	\$1704
		ZONE 2	\$1740
		ZONE 3	\$1777
		ZONE 4	\$1815
		ZONE 5	\$1854

Approximate Shipping weight: 150 lbs

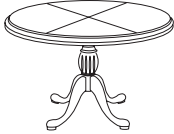
425 Round Table	Dimensions	Zone Grade	Price
	21H 48D	ZONE 1	\$2000
		ZONE 2	\$2042
		ZONE 3	\$2085
		ZONE 4	\$2129
		ZONE 5	\$2175

Approximate Shipping weight: 150 lbs

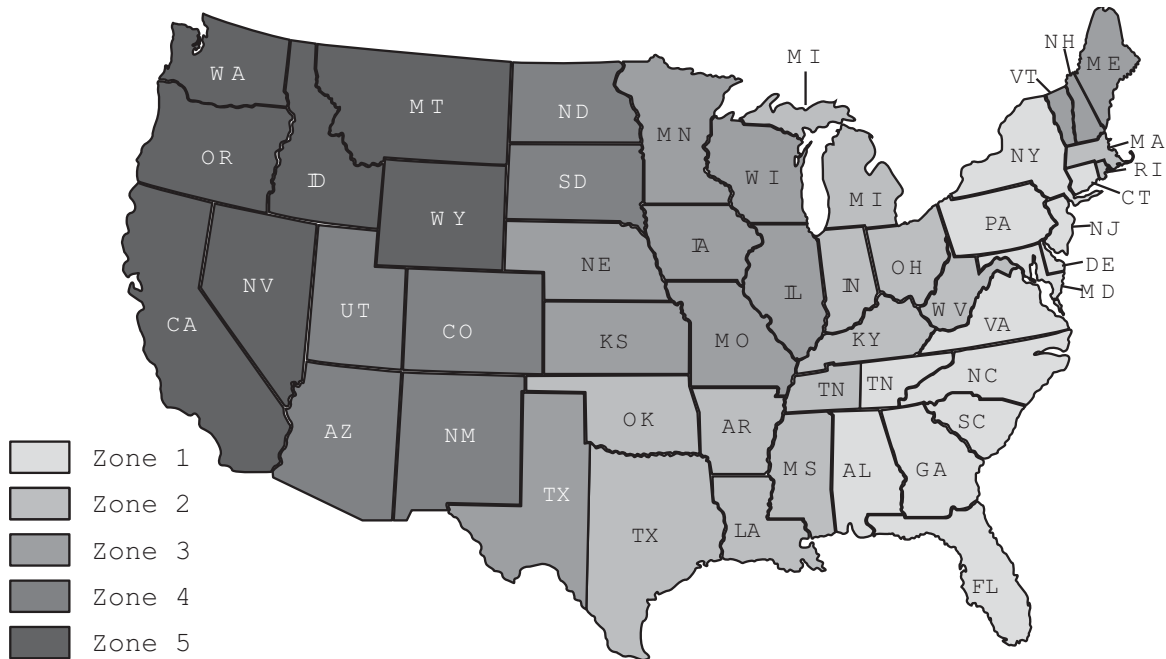

ZONE 1

- ALABAMA
- CONNECTICUT
- DELAWARE
- DISTRICT OF COLUMBIA
- FLORIDA
- GEORGIA
- MARYLAND
- NEW JERSEY
- NEW YORK
- NORTH CAROLINA
- PENNSYLVANIA
- SOUTH CAROLINA
- TENNESSEE (EAST)
- VIRGINIA

ZONE 2

- ARKANSAS
- INDIANA
- KENTUCKY
- LOUISIANA
- MASSACHUSETTS
- MICHIGAN
- MISSISSIPPI
- OHIO
- OKLAHOMA
- RHODE ISLAND
- WEST VIRGINIA
- TENNESSEE (WEST)
- TEXAS (EAST)

ZONE 3

- ILLINOIS
- IOWA
- KANSAS
- MAINE
- MINNESOTA
- MISSOURI
- NEBRASKA
- NEW HAMPSHIRE
- VERMONT
- WISCONSIN
- TEXAS (WEST)

ZONE 4

- ARIZONA
- COLORADO
- NEW MEXICO
- NORTH DAKOTA
- SOUTH DAKOTA
- UTAH

ZONE 5

- CALIFORNIA
- IDAHO
- MONTANA
- NEVADA
- OREGON
- WASHINGTON
- WYOMING

1. All list prices are F.O.B.- Factory freight prepaid and allowed to one destination. All orders are priced according to the zones listed above. The zone is determined by the “ship to” destination. All prices listed are for shipments within the continental United States. Export and shipments to Alaska and Hawaii are freight prepaid and allowed to port of exit.
2. HC reserves the right to select the appropriate carrier for all shipments.
3. Special requests including but not limited to inside delivery residential delivery installation and call before delivery are not included in prices shown and are the responsibility of the dealer.
4. Any charges arising from failure to meet shipment rerouting

while in transit or carrier storage charges are the responsibility of the dealer.

5. Orders of less than 150 lbs. will be assessed a per order NET handling charge. This charge will be waived for items shipped via UPS.

Zone 1	- \$55	Zone 4	- \$80
Zone 2 & 3	- \$65	Zone 5	- \$95

6. HC will make every effort to ship orders complete but reserves the right to part ship when necessary.

TRANSPORTATION CLAIMS

All furniture is carefully inspected and cartoned according to trucking and railroad requirements. The transportation company assumes full responsibility upon acceptance of the shipment. If shipment arrives damaged:

- Note any visible loss or damage on freight bill
- In case of concealed loss or damage notify transportation company immediately and file “Concealed Damage” claim. This should be done within 5 days of receipt of furniture.
- Be sure to retain the carton and packaging for inspection because the carton may not show outside damage.
- Take photos of damage and notify HC.

GENERAL

All orders must be made in writing; faxed to 704.462.2672, mailed to: HC 7514 West NC #10 Hwy Vale NC 28168 or emailed to info@hlc-usa.com.

Possession of this price list does not constitute an offer to sell.

Orders can only be received from Authorized HC Dealers.

Prices shown in this price list are subject to change without notice. Should a typographical error be found HC reserves the right to make changes.

All Dimensions/s shown in this price list are approximate and subject to variation.

TERMS

NET 30 DAYS. Please make payments for HC invoices to HC. All new account orders must be submitted to HC for approval. HC suggests current financial information for new customers to accompany their initial order to avoid approval delays. Allow two to three weeks for the credit approval process.

A 50% deposit payable to HC with your first order will expedite your shipment while credit is being established. All custom orders will require a 50% deposit payable to HC with the order.

ACKNOWLEDGEMENTS

Order acknowledgments will be made for each order and will indicate final production specifications. Buyers should check acknowledgments to be sure that all order details are correct. Orders will not be acknowledged or entered for production until all specification information is complete. Accepted orders are subject to terms and conditions set forth in this price list and on our acknowledgment. This supersedes any variance in terms and conditions on buyer's purchase order.

HC is not liable for any delays or failure to deliver or perform due to fires floods accidents transportation difficulties failure due to delay of sources of supply acts of God or any other causes of like or unlike nature beyond HC's control.

WAREHOUSING

As production space is at a premium orders will be shipped when completed. Any date other than such date must be approved by the factory. If an order is required to be warehoused due to buyer's request a charge will be levied for such (chairs and ottomans - \$20 list per week lounge chairs love seats and sofas - \$45 list per week). All orders being warehoused will be invoiced at normal time of shipping and paid for under normal terms and conditions. Failure of such could affect credit line.

PRODUCT SPECIFICATIONS

DESIGN

HC reserves the right to make changes in design or construction detail without notice; therefore if it is desired that an order match an order previously shipped it must be clearly stated on your purchase order.

MODIFICATIONS/CUSTOMS

HC has the ability to modify existing products and/or manufacture custom products. Please contact factory for information. This includes OEM Products Frames and Parts. All non-standard HC products have a one year limited warranty. Custom orders require a 50% deposit at time of order placement.

FRAME CONSTRUCTION

CANCELLATION

Any order cancelled after it has been placed into production will be subject to a cancellation charge. This charge will be determined by HC based upon where the order is in production at time of cancellation request.

HC will make every effort to meet acknowledged shipping dates. However failure to meet such a date is not cause for cancellation.

WARRANTY

HC warrants to the original buyer that each piece of HC product will be free from defects in workmanship given normal use and care for ten years of single shift service except where noted in this price list.

HC assumes no responsibility for improper assembly modification abuse alteration negligent use or unauthorized repair work by the buyer.

This warranty does not cover: damage caused by a carrier; C.O.M. or C.O.L; gas cylinder-pneumatic lifts casters and mechanisms beyond the OEM warranty; color grain or texture of woods and other covering materials due to natural variations over which HC has no control.

HC does not offer warranty on textiles beyond what is offered by the supplier.

HC will either replace or repair at our option any parts of the product found to be defective within the terms of warranty. Such is the buyer's sole remedy. HC shall not be liable for consequential or incidental damage to persons or property.

Except as stated herein HC makes no expressed or implied warranties of merchantability or fitness of any HC product for any particular purpose.

All non-standard HC products have a one year limited warranty. All repair charges must be authorized in writing by HC for warranty work. Only after receipt of repair bill from party performing repairs will a credit or reimbursement take place. Do not return any merchandise without written permission from HC. Only warranted product will be considered.

Light finishes tend to highlight rather than mask the natural characteristics and color variation of wood which are not considered defects by HC. Likewise leather is characterized by variation in color from hide to hide and within hides and should be expected. Healed scars scratches insect bites and wrinkles are not considered defects in the leather.

WARNING

Direct sunlight can fade finishes leathers and upholstery; and can dry out leather and degrade some vinyl covers. HC cannot control nor be held responsible for sunlight damage.

PRODUCT SPECIFICATIONS

Our wood lounge frames are bench made exclusively in North Carolina by local craftsmen who have been building furniture in this area for generations. We use only kiln-dried Beech or beech hardwood (5/4 size minimum) or durable engineered wood panels crafted of multilayered solid wood veneers to reduce movement, twisting and warping. Key joints are reinforced with traditional double dowels, corner blocks and interlocking joints to withstand weight and stress. Exposed wood furnishings are handcrafted of the finest Beech or beech hardwoods. Rails are double doweled and corner blocked for maximum strength. All corner blocks are screwed and/or stapled to insure strength.

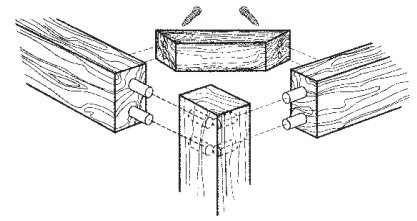

SPRING AND SEAT CONSTRUCTION

HC's primary spring and seat construction is the eight-way hand tied system. When eight-way construction is not possible due to design HC will use an appropriate seat construction based on industry standards.

- **Eight-Way Hand Tied System**

The best spring construction available when chair design allows. Provides comfort and long life by utilizing double coil springs tied to each other and frame rails. This allows springs to move only in a vertical motion and distribute weight load equally to chair rails.

Materials

- Eight and nine gauge solid carbon steel double coil springs.
- 100% waxed #6 nylon string.
- Eight knots per coil at top.
- Paper lined steel fastener secures coil to bottom.
- 54 strands/inch #650 Woven Poly Propex bottom.
- 7/8" steel nails attach strings to rails.
- System covered with FLW Polywoven material.

- **Rubber Webbing System**

Simple spring construction for Contemporary and Transitional seating that require very thin scaled designs. Provides comfort and strength by attaching rubber webbing from the front rail to the back rail and across seat from side rails.

Materials

- Ultraflex Type #550 rubber webbing 2" wide with 20% stretch load
- #10 steel staples attach webbing to frame rails.

- **No Sag System**

The best spring construction for designs that do not allow for eight way hand tied system. Used on most Contemporary and Transitional style seating and as a cost savings on Traditional style seating. Provides comfort and strength by using sinuous wire springs that are connected to front and back rails. These springs are then held together by a coated wire clipped to each spring.

Materials

- Eight and ten gauge sinuous wire springs in continuous 2" wide loops. These springs are spread 4" on center across seat.
- Coated stabilizing wire.
- System covered with FLW Polywoven material.

- **Foam Over Propex**

Simple seat construction for Contemporary and Transitional seating that require very thin scaled designs. Provides comfort and strength by attaching Polywoven propex material to all four side rails then covering with foam.

Materials

- #650 woven poly propex with 54 strands per sq. inch
- 500 7/16" steel staples attach propex to rails.

MECHANISMS

- **Manual Swivel Tilt Control** - Used for medium and large fixed back tilting chairs this spring control employs a low fulcrum and a dual "floating spring" concept to ensure both a balanced and stable ride throughout the full tilting range. Nylon contacts rubber cushion shock absorbers and self-lubricating fiberglass reinforced nylon bearings provide for long lasting quality.

Adjustments: A. Tilt tension control knob
B. Manual height adjustment

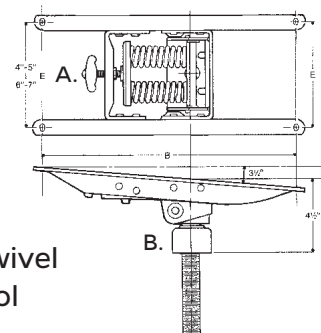

Typical Swivel
Tilt Control

PRODUCT SPECIFICATIONS

MECHANISMS (continued)

- Knee Tilt Controls - Used for fixed back tilting chairs the forward positioning of the fulcrum permits the chair to tilt back from the front edge. This results in minimum vertical knee movement alleviates upward thigh pressure and improves access to lower desk areas. Its streamlined design and construction exceeds ANSI/BIFMA standards and offers permanently lubricated reinforced nylon bearings. This mechanism is offered with either mechanical or pneumatic height adjustment.

Adjustments: A. Tilt tension control knob
B. Pneumatic height adjustment lever
C. Manual height adjustment
D. Tilt lock push/pull rod

Typical Knee
Tilt Control

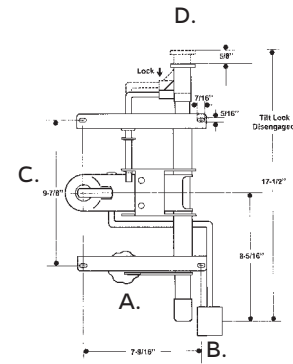

BASES

Bases E and L are constructed with solid steel understructures and solid hardwood base caps. Base P is cast fiberglass reinforced nylon.



E - \$225



L - \$200



P - \$65

PRODUCT SPECIFICATIONS

FINISHES

HC has eight key steps in the finishing process. These steps and the use of a catalyzed lacquer provide all products with a high quality long lasting finish. The steps are as follows:

1. Primary Machine Sand 100-120 Grit
2. Secondary Hand Sand 150-220 Grit
3. Apply Stain
4. Apply Sealer
5. Sand 280 Grit
6. Apply First Coats of Catalyzed Lacquer
7. Sand 320 Grit
8. Apply Second Coats of Catalyzed Lacquer

HC applies the finishes listed below to exposed beech/maple hardwood. If a different species of wood is required please contact the factory for price and availability.

Standard Finishes

Hickory Contract offers 10 standard wood grain finishes and 10 laminate choices. You may view these selections on line or inquire with customer service for samples.

Mahogany	Cherry
Walnut	Light Cherry
Black	Natural Maple
P. Mahogany	Pecan*
Oak	Kona

Light Finishes

HC offers several light finishes and custom matches many. These finishes do not hide or mask the natural characteristics of the wood. Both dealer and customer should understand that the natural characteristics of the wood will be a characteristic of the product. Natural characteristics of the product include the natural discoloration of the wood substance and color variations in glued up stock. These natural characteristics are not considered defects by HC and therefore will not warrant replacement or repair.

Custom Finishes

Hickory Contract will match other manufacturers finishes. Please submit a sample with your purchase order. Hickory Contract will have sole discretion concerning the correctness of the match unless an approval samples is requested and approved. The charges for custom finishes are as follows:

\$250 LIST per order
\$125 LIST per approval

The beauty of the wood is the result of natural variations in color and grain. Since no two trees are exactly alike, all woods may vary in color, grain configuration and stain acceptance. Therefore, even though veneers and solids are carefully selected, an exact matching of color and grain cannot be guaranteed.

WELT GUARDS

A 10" long clear Polyvinyl welt guard is standard on all Traditional Executive Swivel Chairs. Please note on order if guard should be deleted.

COMBINATIONS/CONTRASTING WELTS

For contrasting welts or contrasting fabrics please add \$25.00 list/chair \$35.00 list/loveseat and \$45.00 list/sofa.

FIRE RETARDANT CODES

Most products are manufactured to meet California Technical Bulletin 117. HC can manufacture its product with components which should allow the product to meet California Technical Bulletin 133 Requirements. Please contact the factory for pricing. Should certification be required customer is responsible for cost of sample and testing fees.

CUSHION TIE STRAPS

For tie straps which prevent lounge cushions from being easily removed add \$40.00 list/chair \$120.00 list/loveseat and \$160 list/sofa.

LUMBAR BACKS

Additional lumbar support is available on many products. Please consult product pricing pages or the factory for availability and charge.

LEATHER

No two pieces of leather furniture are exactly the same. Color variations and distinctive natural markings make each piece of leather furniture unique.

Color variation is a natural occurrence with pure aniline dyed top grain leathers. In the dying process no pigments are used. Each hide absorbs "color" in varying amounts based on individual cell structure so even areas within the same hide may vary in color.

Color variation is an inherent quality of the antiquing process in hand antiqued leather.

Healed scars scratches insect bites and wrinkles provide yet another Dimensions/ of individuality to leather. All of the above are natural characteristics of leather and are not considered defects by HC.

NAILHEADS

The standard nailhead offered on all Hickory Contract furniture is a ½" French Natural (brass). We offer at no additional charge 5 other choices. You may view these selections on our website or contact customer service for additional information.

CUSTOMER'S OWN MATERIAL

CUSTOMER'S OWN MATERIAL (C.O.M)

All items are available with material furnished by the purchaser and should be priced in grade A. Yardage requirements listed in our price list are based on 54" wide plain material. Generally additional yardage is required if striped or patterned material is used if pattern requires matching or if width of materials is less than 54" wide. HC strongly recommends a sample of the C.O.M. material be submitted for review and approval prior to ordering. We can take no responsibility for tailoring wearability or application of C.O.M. covers.

TEXTILE GRADING

COM should be priced in Grade "A". COL should be priced in Grade "C". COM COL and all leather grades are noted in header above each products zoned pricing.

C.O.M CHART

Though every effort has been made to estimate excess yardage required for stripes and matches HC takes no responsibility where additional material must be ordered. HC will supply yardage requirements for large quantities revisions and special match upon request.

Refer to the following guideline when figuring C.O.M. requirements:

Railbanded							
Fabric Width	Plain Fabric	Repeat					
		1-5"	6-9"	10-13"	14-20"	21-27"	28-34"
54"	0%	+10%	+15%	+20%	+25%	+30%	+35%
50"	+15%	+15%	+20%	+25%	+30%	+35%	+40%
48"	+20%	+20%	+25%	+30%	+35%	+40%	+45%

"Railroad" or "Top to Selvage"

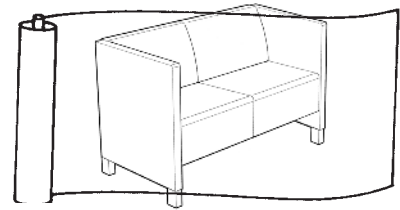

Up The Roll							
Fabric Width	Plain Fabric	Repeat					
		1-5"	6-9"	10-13"	14-20"	21-27"	28-34"
54"	0%	+15%	+18%	+25%	+30%	+35%	+40%
50"	+15%	+20%	+25%	+30%	+35%	+40%	+45%
48"	+20%	+25%	+30%	+35%	+40%	+45%	+50%

Up the Roll

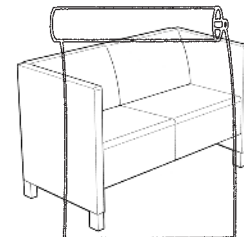

ALL C.O.M.'s AND C.O.L.'s

In absence of specific written instructions accompanying the order fabrics will be cut seamed and applied at HC's discretion and at customer's risk. While HC inspects fabrics for mill imperfections some are difficult to recognize. HC cannot be responsible for defects color inaccuracies dye lot variations/flaws and suggests that our customer inspect fabrics before furnishing them to the factory. HC will make a concentrated effort to control C.O.M. and C.O.L. materials. It is not HC's responsibility to police the receipt of C.O.M. and C.O.L. material in order to meet delivery deadlines and we assume that customers are aware of any undue delay in the delivery of their C.O.M. and C.O.L. materials. All C.O.M. and C.O.L. must be clearly tagged with customer name/ Purchase Order Number/Product Number.

SHIP C.O.M. PREPAID

HC
7514 West NC #10 Hwy.
Vale NC 28168 ATTN: COM/COL Dept.

HC TEXTILE PROGRAMS

HC's textile program offers five types of leathers and over 10,000 different choices of fabrics and vinyls. For grading information, please visit our website at www.HickoryContract.com and visit the textile page.

MAYER

The entire Mayer line is available through HC. For free memo samples call Mayer Fabrics at 800-428-4415. www.mayerfabrics.com



ULTRA FABRICS

The entire Ultra Fabrics line is available through HC. For fabric samples call 877.309.6648. www.ultrafabricsllc.com



MOMENTUM

The entire Momentum line is available through HC. For free memo samples call Momentum at 800-366-6839. www.memosamples.com



DOUGLAS

The entire Douglas line is available through HC. For fabric samples please call 800.950.3684. www.douglassfabrics.com



CF STINSON

The entire CF Stinson line is available through HC. For free memo samples, contact CF Stinson at 800-841-6279



CULP FABRICS

The entire Culp Fabrics line is available through HC. For fabric samples call 336-888-6274. culpcontract.com



HC LEATHER PROGRAMS

RIO

RIO is the go to leather when the demand for durability and value are the top priority. The color options are a minimalist approach that is current and relevant. RIO is dyed for color then pigmented to provide color consistency and a protective finish which is perfect for high traffic areas.

BELLA

Casual elegance and a large color palette make BELLA an easy choice when selecting leather. This color consistent and durable upholstery leather provides a soft drape and hand that tailors exceptionally well. Produced on select European hides this collection provides a premium quality at an affordable grade. BELLA is specified to meet the requirements for contract and hospitality uses.

SANTA FE

SANTA FE is a smart choice for the customer looking for a wax/crackle leather that won't easily scratch. SANTA FE provides that desirable vintage look but offers a protective finish making it suitable for high traffic area. Each hide is aniline dyed and receives a special protective wax top coat for durability and softness. Due to the inherent nature of this raw material, scratches, bruises, scars and insect bites may be noticeable but only add to the richness of this vintage leather.

AVALON

Avalon is a top grain, lightly corrected semi-aniline leather Powered by Crypton, which is bleach cleanable, antimicrobial, antibacterial and stain resistant. Fully aniline dyed and highlighted by a pebble grain, Avalon is available in 25 design driven colors. Durable and ideally suited for healthcare and hospitality applications, Avalon is environmentally friendly and solvent free.

HEIRLOOM

All of the beauty that makes an antique leather desirable is offered in HEIRLOOM at a value price. The subtle hand-wipe effect adds dramatic color depth and produces a two-tone look that is ageless and inviting.

VINTAGE

VINTAGE is a domestic top grain, aniline dyed leather that features Old World craftsmanship of a hand rubbed antiqued finish and is frequently referred to as a glazed leather because of its high sheen. The authentic hand antiquing gives this fine leather its distinctive and unique look. Environmentally friendly, Vintage is available in 9 relevant colors and is an excellent hand antiqued leather choice for the discriminating contract customer.



HC ENVIRONMENTAL POLICY

HC's environmental effort begins by designing and building durable products backed by a ten year warranty. This is a goal aimed at preserving natural resources. It means our products limit the "dispose and repurchase" cycle that constantly burdens our environment with used and wasted furniture.

The safety of employees the community and environmental factors are also considered in the design of products and all production processes. HC's two manufacturing facilities function in full compliance with all applicable EPA and OSHA regulations.

HC identifies the environmental aspects of its business activities manufacturing operations products and services and then strives to prevent or reduce environmental impacts within our control including application of the best available technology and management practices.

HC's Environmental Policy and Goals include:

- Hardwoods from suppliers who practice conservation and reforestation programs not utilizing wood species from endangered rain forests
- Parts manufactured by approved suppliers who apply modern technologies that are not harmful to the environment
- Beech frame construction which is free of formaldehyde often used by others utilizing plywood in their construction
- Technology that maximizes the best and highest quality yield
- Chemicals and adhesives that are formulated to meet or exceed environmental standards
- Alternate packaging methods such as blanket wrapping to reduce use of cardboard packaging
- Transportation management system that contracts with trucking lines who efficiently time shipments to ensure as full as possible shipments to conserve energy
- Maximize use of recyclable packaging materials
- Many recycled materials in the operation of the administrative promotional and financial activities that occur in the operation of HC's daily business

HC also employs processes and materials that prevent reduce or minimize pollution. This includes control mechanisms material substitution efficient use of resources and recycling.

HC will continually explore creative responsible ways to do business and manufacture products so as to better preserve our natural resources and protect the environment for future generations.